

# OWNER MANUAL

Rev. 02 | Ed. 02 | 01/2022  
Cod. X4544081



## X-CAPE 650

VEHICLE DESIGNED IN ITALY, PRODUCED AND ASSEMBLED IN CHINA



*Dear Customer,*

- *Congratulations on your excellent choice.*
- *Your new motorcycle is the result of the strictest tests and it represents the most up-to-date display of technology in this field.*
- *A trouble-free operation of the motorcycle through time depends on the use it will be subjected to and on appropriate maintenance. For this reason, we strongly suggest you conform to the information stated in this booklet, which must be carefully read before operating the motorcycle and will have to be consulted any time there is even the smallest doubt. In case you should lend your motorcycle (we strongly discourage doing so) to a friend, make sure they have read the paragraphs concerning riding safety and use of the motorcycle itself.*
- *For servicing, extraordinary maintenance, spare parts and accessories always and exclusively refer to Moto Morini authorized Service Centers.*
- *This manual must be preserved for the whole life of the motorcycle and in case of transfer of title it will have to be handed over to the new owner.*
- *All information reported in this manual is up-to-date as of printing date.*
- *Moto Morini reserves the right to apply all changes required by the evolution and development of its motorcycles without notice obligation.*

***Always abide by the traffic laws, ride carefully and... Have a good journey!***

## Accompanying documentation of the motorcycle

- User Manual  
(Including Warranty booklet).

## Motorcycle identification data

A = VIN ZLMPMVAB...

B = homologation tag

### NOTE

Falsification of identification data is punishable by law. Do not remove the tag (B) reporting homologation data.

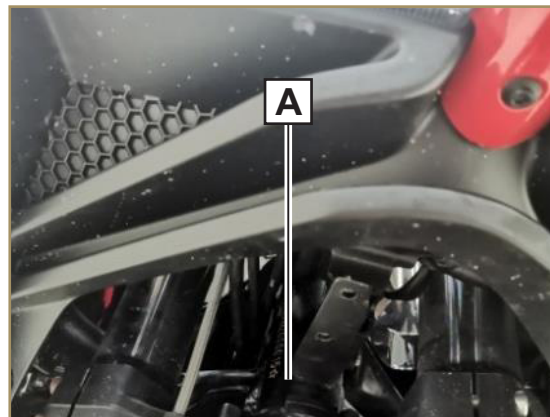

CATALOG		
Dear Customer, .....	1	
<b>Accompanying documentation of the motorcycle ...</b>	<b>2</b>	
<b>Motorcycle identification data .....</b>	<b>2</b>	
<b>Consultation Notes .....</b>	<b>5</b>	
Symbols .....	5	
Basic rules .....	6	
Clothing .....	10	
Riding with a passenger .....	10	
Accessories .....	10	
Load (Baggage) .....	11	
<b>Technical features .....</b>	<b>12</b>	
Engine .....	13	
Timing system .....	13	
Fuel system .....	13	
Exhaust system .....	13	
Valve clearance .....	13	
Lubrication .....	14	
Cooling system .....	14	
Transmission .....	14	
Homologation .....	15	
Overall dimensions .....	16	
Electrical System .....	16	
Fluids/Lubricants .....	18	
<b>General Information .....</b>	<b>18</b>	
Main component location (Headside) .....	18	
(Left-Head side) .....	18	
(Right-hand side) .....	19	
Supplied equipment .....	19	
Provided keys .....	22	
Ignition Switch .....	23	
Fuel Tank Cap .....	24	
Passenger Seat lock .....	25	
Main seat .....	26	
Dashboard .....	27	
Indicator light(Specific function) .....	28	
Basic information of vertical menu .....	31	
1.Setting function menu: .....	33	
2.Device connection .....	35	
Device deletion .....	36	
3.Screen display:		
including selection view, brightness .....	37	
4.System information: There are settings for language, unit, and timefunctions. ....	41	
Basic information of horizontal menu .....	47	
Basic information of display function .....	49	
Basic information of warning function .....	53	
ABS basic information .....	54	
Start of ABS .....	55	

1. "Overtaking(passing) lights" button- .....	56	<b>Terms of use .....</b>	<b>73</b>
2. Horn button- .....	56	Run-in (1,000 km) .....	74
3. Turn signal button- .....	56	Check items before use .....	75
4. Light switch button- .....	56	Riding skills .....	76
5. Instrument operation buttons- .....	56	Safety precautions for the first use of motorcycles .....	77
Right hand switch .....	56	<b>Maintenance .....</b>	<b>87</b>
Clutch lever• .....	57	<b>Regular replacement .....</b>	<b>91</b>
Distance adjustment .....	58	Daily maintenance .....	92
Front Brake lever .....	58	Engine oil .....	93
Distance adjustment .....	59	Brake fluid .....	95
Throttle Cable control .....	59	Liquid level check .....	96
Adjusting the throttle Cable .....	60	Coolant .....	97
Front fork .....	62	Brake pads .....	99
Compression damping (adjustment (B)-left fork) .....	63	Transmission Chain .....	100
Rebound damping (adjustment (B)-right) .....	63	<b>Electrical components .....</b>	<b>101</b>
Rear shock absorber .....	64	Fuses .....	101
Rebound adjustment .....	65	Battery .....	103
Gear shifting lever .....	66	Battery Maintenance .....	103
Start .....	66	Remove the battery .....	104
Gear shift: .....	66	Re-Install the battery .....	105
Position adjustment .....	67	Headlamp .....	106
Rear Brake Pedal .....	68	Turn signal .....	107
Adjust the position of the rear brake pedal .....	68	License plate light .....	107
Side Stand .....	69	Tail light .....	107
Tires .....	70		
Fuel Tank .....	72		

## Consultation Notes

### Symbols





- Symbols highlighting situations of maximum attention, practical advice or information have been used in order to ensure a quick and practical reading.
- Said symbols can be located next to a text (thus referring to that text only) next to a picture (referring to the subject of the picture and its text) or at the top of the page (referring to all topics treated in the page itself).

### NOTE

Pay attention to the meaning of the symbols: their purpose is to avoid repetition of technical concepts or safety warnings.

### NOTE

Some pictures could differ from the motorcycle in use.

SYMBOL	DESCRIPTION
	<b>WARNING!</b> Dangerous situations with grievous bodily harm or even death.
	<b>IMPORTANT</b> Possibility of damage to the motorcycle or parts of it.
	<b>NOTE</b> Topic of specific importance.
	<b>INTERVENTIONS</b> Interventions pertaining to the Authorized Service Centre.
	<b>OPERATIONS</b> Operations to carry out with the engine off.

## Basic rules

- It is necessary to have all the requirements provided for by law in order to ride the motorcycle: minimum age, psychophysical eligibility, etc. in addition to the country-specific required documentation: driving license, registration, road tax, insurance, number plate etc..
- Good psychophysical conditions are essential for safety while riding the motorcycle. Drugs, alcohol abuse, psychotropic drugs etc., in addition to physical weariness and sleepiness can cause very dangerous situations.
- It is advised to use a helmet, in compliance with the current regulations in the reference country.
- It is advised to use all protective devices, reinforced jacket, boots and gloves.
- It is advised to become familiar with the motorcycle by initially riding it in low-traffic areas.
- A good percentage of motorcycle accidents are caused by the rider's inexperience.
- Never lend the motorcycle to beginners or inexperienced riders.
- Ride in a seated position, both hands firmly placed on the handlebar and feet correctly placed on the footrests. Avoid standing up and stretching out the legs while riding. In case of numbness of the limbs on long-distance routes, do not hesitate to stop in specific rest areas and do some simple exercise to restore blood flow and tone up the muscles. Never ride in a state of physical weariness or drowsiness.
- Rigorously abide by signage and national/local rules.
- Keep a safe distance from other vehicles when riding in a straight line.
- Always ride with the low beam switched on, even in daylight.
- Avoid abrupt and potentially dangerous moves.
- Adjust your riding style according to road surface.



- Adjust your riding style according to the additional load carried on the motorcycle, especially in presence of a passenger.
- It is forbidden to challenge other vehicles' drivers on public roads.
- Avoid riding the motorcycle off-road as much as possible.
- When the road is wet or slippery, ride with maximum concentration. Use the brakes gently and mainly use the engine brake.
- Always ride so to be very visible in every condition. Do not ride in the “blind spots” of the vehicles in front of you.
- Pay extreme attention at crossroads that have no traffic lights, when close to an access to private areas or public parking areas, in entry lanes to ring roads or motorways.
- When refueling the motorcycle, always switch the engine off. Do not smoke when performing the aforementioned operation.
- Remove the ignition key during stops (even short ones) if the motorcycle is left unattended.
- Park the motorcycle so that it cannot be bumped into, especially by pedestrians as the engine, the exhaust pipes and the silencer maintain a high temperature for a long time.
- Never park on rough or soft terrains or asphalt that has been softened by sunlight.
- Changes of direction or lane, side street turns, pull overs for parking or stopping must always be signaled well in advance by using the direction indicators.
- Whenever close to crossroads, stops, traffic lights, level crossings, holes, ditches, speed bumps and any other perceivable obstacle, slow down in time with moderation.
- When the engine is switched off and the ignition key is positioned to “ON”, the low beam switches off

after a few seconds.

- Before every trip, always check: tire wear and pressure, efficiency of the lighting and braking systems, engine oil and coolant levels.
- Only use the products recommended by Moto Morini. In case of any top-ups, avoid mixing different, incompatible oils with one another.
- Do not ride with the helmet hanging off your arm or off the handlebar, even for short commutes. The helmet must be worn during every motorcycle ride (this applies to the passenger as well).
- Never distract oneself or get distracted while riding.
- Do not use mobile or audio devices while riding.
- Do not use earphones, only use appropriately homologated devices for these purposes.
- Alterations and tampering (even minor ones) exempt the manufacturer from any responsibility regarding any kind of damage and cause the termination of the warranty rights

**WARNING!**

**Do not ride in the stream of the vehicles ahead.**

**Do not ride paired up to other riders.**

**Do not tow or get towed by other vehicles.**

**Do not sit on the motorcycle while it is parked on the kickstand.**

**Do not put the motorcycle on the kickstand when the travel direction goes downhill.**

**Do not start the engine in indoor spaces.**

**Do not ride on pedestrians' walks, under covered walks, on public park lawns, etc.**

**Do not keep pointy or fragile objects in your pockets while riding.**

**Do not ride in case of adverse weather conditions (temperatures close to 0° C, ice, snow, heavy rain, etc.).**

## **Clothing**

- Appropriate clothing consists of protective garments in light or refractive colors in order to always be perfectly visible even in poor visibility conditions. Avoid any loose-hanging tails, unbuttoned jackets, excessively heavy or tight gloves and inappropriate shoes.

## **Riding with a passenger**

- Carrying a passenger on the seat influences the riding to a great extent. The weight has a direct effect on the tires, whose pressure will need to be increased and on the rear shock absorber, that will have to be calibrated properly. The braking distance is considerably longer and bends have to be taken at a wider range, with a reduced lean angle and measured throttle opening. A higher degree of caution is also mandatory.
- Both rider and passenger must necessarily wear homologated, properly tied up helmets. The helmet must be properly sized, intact and with a perfectly clean visor.
- Briefly instruct the passenger on the behavior they will have to adopt before every trip (even short ones): do not make any abrupt move during the ride, do not place the feet on the ground during short rests such as stop signs or traffic light stops, do not look over the sides during the ride to look ahead, do not turn the head backwards and, above all, do not counterbalance the curve preparation set by the rider.
- Clear display of passenger anxiety must necessarily lead to highly cautious and careful driving.

**WARNING!**

**Do not carry elderly or disabled people, children or animals.**

**Do not carry children on the motorcycle tank.**

**Accessories**

- Moto Morini shall not be liable for any kind of damage resulting from the use of unexpected, non-homologated or in any way incompatible accessories according to the structural features of the motorcycle or accessories that have not been installed following the technical specifications of said accessory's manufacturer or Moto Morini or accessories that are not officially approved by Moto Morini's technical department (example: windscreen, luggage rack, top case, side panniers or bags, fairings, additional lights, etc.).
- The motorcycle user is responsible for the choice, set-up and practical use of the accessories. During set-up, it is important to verify that the visual and acoustic indication devices are not covered, the suspension travel and steering angle are not limited, the use of control devices is not hindered and ground clearance and leaning angle are not reduced.
- Always check that the accessories are properly attached to the motorcycle, especially in view of long journeys.
- Any accessory that modifies side and/or frontal clearances can cause vehicle imbalance, even if it is an original Moto Morini accessory. In these cases, it is advised not to exceed a 130 Km/h speed even if allowed.

**NOTE**

Always use original Moto Morini Accessories set up by the authorized Service Centre.

## Load (Baggage)

- Baggage must be loaded so that its total weight is equally distributed on both sides of the vehicle, as close to its barycenter as possible. Baggage must be securely attached to the vehicle and it is good practice to check its correct anchoring during stops. A poorly anchored bag can make the motorcycle unsteady and cause extremely dangerous situations.



### WARNING!

**Do not position bulky baggage at the sides of the motorcycle; it could hit obstacles or people, causing a loss of control of the motorcycle itself.**

**Do not fasten any type of object to the handlebar.**

**Do not fasten any type of object to the front mudguard or close to the fork. This causes poor handling and hinders the regular air flow to the radiator, thus increasing the dangerous risk of the engine overheating.**

**Do not carry baggage or various types of objects sticking excessively out of the luggage rack or covering the lighting and signaling devices.**

**Do not exceed the maximum weight limit of the luggage rack. Overload is always a dangerous element while riding a motorcycle.**

**Do not exceed the load on the tank, especially height-wise.**

## Technical features

### Engine

Twin-cylinder .....	4-stroke, DOHC, Twin Cylinders
Total displacement .....	649 cm <sup>3</sup>
Bore by stroke .....	83 x 60 mm
Compression ratio .....	11.3:1
Power (E5) .....	44 kW - 8,250 rpm.
Engine torque (E5) .....	54 Nm at 7000 rpm
Power A2 vehicles (E5) .....	32,5 kW - 9,000 rpm
Engine torque A2 vehicles (E5) .....	50,5 Nm at 5750 rpm

### Timing system

Double camshaft (Hydraulic tensioner)

### Fuel system

Electronic fuel injection



Ø38mm throttle body.

### Exhaust system

Silencer, 3-way catalytic converter and 2 LAMBDA sensors.

## Valve clearance

Intake.....	0.08-0.13mm
Exhaust.....	0.2-0.26 mm

## Lubrication

Oil: .....	Power Synt 10W40
Capacity*: draining .....	2.6L;
with filter replacement.....	2.2L;
without filter replacement.....	2L

## Cooling system

Liquid.

Thermostat starts opening:.....	73-77°C
---------------------------------	---------



## Transmission

- 6-Speed gearbox.
- Final drive ..... 15/46
- Gear ratio: Beginning - (2.095), **1st**-2.353, **2nd**-1.714, **3rd**-1.333, **4th**-1.111, **5th**-0.966, **6th**-0.852.
- Primary drive: spur gears.
- Final drive: chain.
- Clutch: multi-disks wet type.

## Homologation

### Euro 5 vehicle

- Frame: steel tube structure  
Swing-arm: Aluminum die-casting  
Wheelbase: 1482mm-Rake angle: 25° Track: 122mm-Steering angle: 39°
- Front suspension: adjustable inverted fork Ø50mm.–Stroke: 175mm
- Front wheel (standard): A356 aluminum wheel — 2.50x19” – tire: 110/80-R19”
- Front wheel (high configuration): STS 36T spoked wheel — 2.50x19” — Tire: 110/80-R19”
- Rear suspension: adjustable single shock absorber-stroke: 47mm
- Rear wheel (standard configuration): A356 aluminum wheel — 4.25x17” – tire: 150/70-R17”
- Rear wheel (high configuration): STS 36T spoked wheel — 4.25x17” — Tire: 150/70-R17”
- Brake Front:  **brembo**  
Double disc Ø298mm. Caliper with 2 pistons and 2 brake pads per side. Rear: Single disc Ø255mm.  
Caliper with 2 pistons and 2 brake pads.
- Fuel tank capacity: 18L.
- Dry weight: 213kg

# X-CAPE 650

Caution  
 The tire load grade and speed on the motorcycle shall be  
 control up in accordance with Technical Document 6.1.1.1.1.

Tire sizes and air pressure	Driving advice
Front: 110/70-17 M/C 80H	Do not overinflate tires
Rear: 150/70-17 M/C 80H	Do not overinflate tires
Do not use tires with 50 PSI (3.45 bar)	Do not use tires with 50 PSI (3.45 bar)
Do not use tires with 50 PSI (3.45 bar)	Do not use tires with 50 PSI (3.45 bar)
Do not use tires with 50 PSI (3.45 bar)	Do not use tires with 50 PSI (3.45 bar)

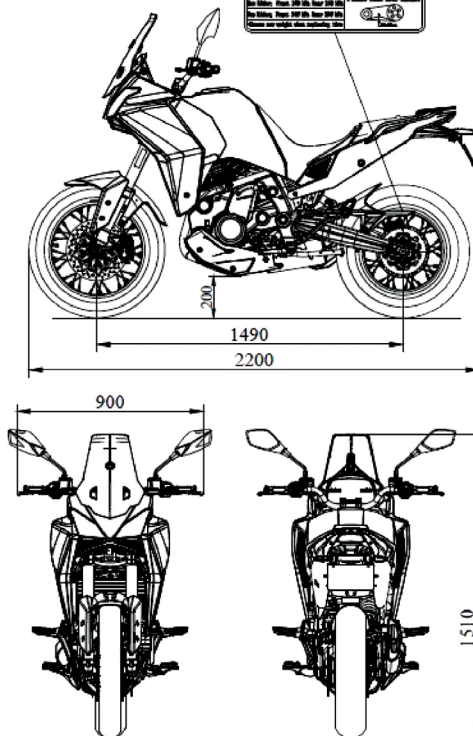



## **Overall dimensions**

### **Electrical System**

- Battery: 12V - 11Ah
- Instrumentation: Multi-function LCD Display.
- Spark plugs: CR8EI

### **Fluids/Lubricants**

- Fuel: leaded petrol R.O.N. 95#
- Coolant: COOLANT G40
- Engine oil: 10W40-SN 
- Brake and clutch fluid: BRAKE FLUID DOT 4 

## General Information

### Main component location (Headside)

No.	Instruction
1	Earview mirror
2	Clutch handle
3	Left handle switch
4	Handlebar press block (adjustable 6 levels)
5	Right handle switchw
6	Handgrip Gas
7	Front brake lever
8	Front brake fluid reservoir
9	Ignition switch/steering lock
10	Windshield
11	Dashboard

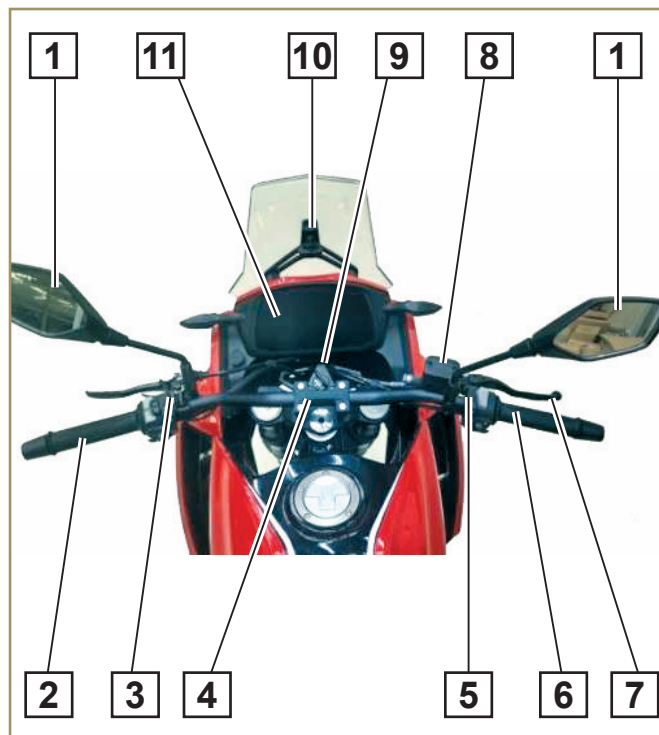

**(Left-Head side)**

No.	Instruction
1	Left front brake caliper
2	Auxiliary water tank engine coolant
3	Exhaust pipe
4	Shift lever
5	Side stand
6	Left pedal
7	Drive chain
8	Passenger seat
9	Rider seat
10	Radiator-engine coolant



**(Right-hand side)**

No.	Instruction
1	Rear brake caliper
2	Right pedal
3	Rear brake pedal
4	Front catalytic converter
5	Right front brake caliper
6	Headlamp
7	Fuel tank cap
8	Rear brake fluid reservoir
9	Silencer



## Supplied equipment

The vehicle comes with on-board tools:

- Allen wrench (1): Allen wrench.
- Replaceable screwdriver (1): flat head- cross head.
- Wrench (2): size 8-10; size 14-17.

The vehicle tool is located under the passenger seat

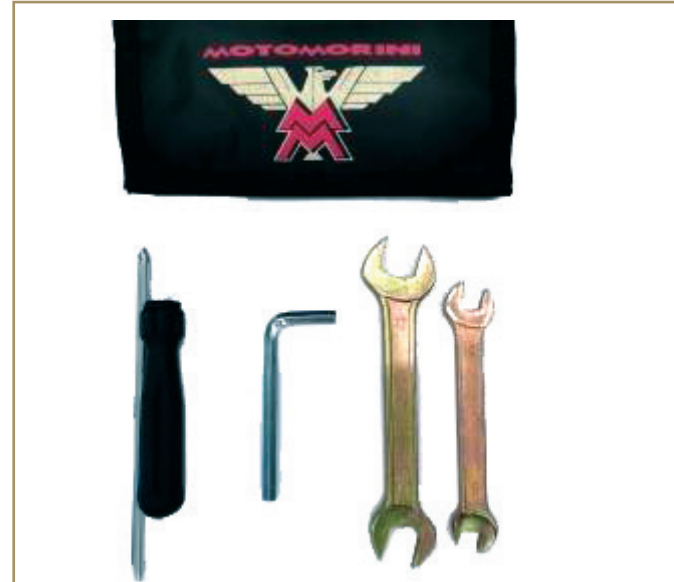



## »-CAPE 650

### Provided keys

- The motorcycle is delivered with 2 pcs of identical keys.

### NOTE

- Separate the two keys and store one of them in a safe place.
- It is recommended to save the key picture for copy after loss(the picture is real key).



### IMPORTANT

It is advised to use a keyring made out of soft material that will not mark the exterior of the motorcycle.

### NOTE

- In case of a key loss, report it as lost and, if necessary, head to the Service Centre for locks replacement.

## Ignition Switch

- Located between the handlebar and the fuel tank, there are three lock positions, which are operated by keys.

Location instruction:

- A. No power, the circuit is disconnected;
- B. Ignition power supply, all electrical equipment can be used;
- C. Steering lock.

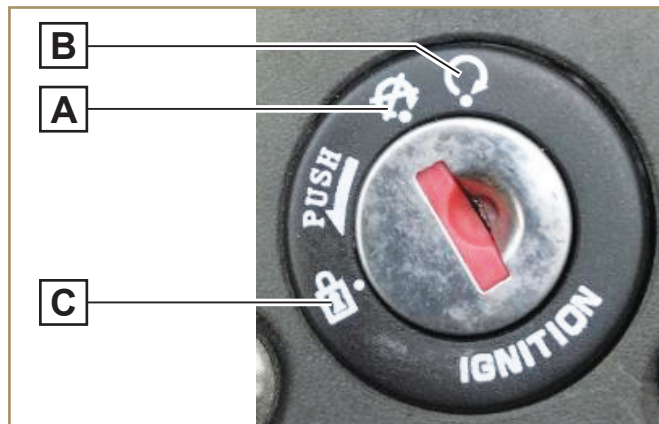

### NOTE

To avoid battery discharge, start the engine as soon as possible after turning the ignition key to the "A" position; if you stay in the "A" position for a long time, the battery power may be exhausted; The key can be pulled out when it is turned to the stall or to the steering lock position;



### IMPORTANT

Press the key downwards in order to rotate it and shift it through the different modes.

When the steering lock is activated, the key needs to be pressed down and turned counterclockwise to the corresponding position at the same time;

## Fuel Tank Cap

### Opening

Before opening the fuel tank cap, pull up the key-hole cover; insert the ignition key(A) into the fuel tank cover, push it into place, turn the key clockwise, and then tilt the cap(B) back;

### Close

To close the fuel tank cap(B), turn the key(A) clockwise and push the fuel tank cap until it makes a "click" sound. To remove the key, turn it counter-clockwise to the initial position, remove it, and then close the keyhole cover.

### **NOTE**

After each refueling, check the cap is properly closed.

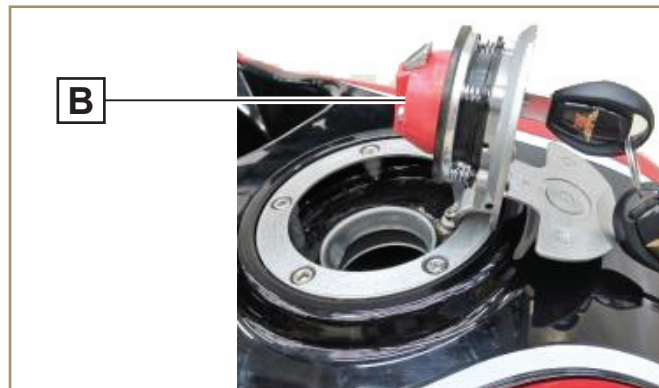
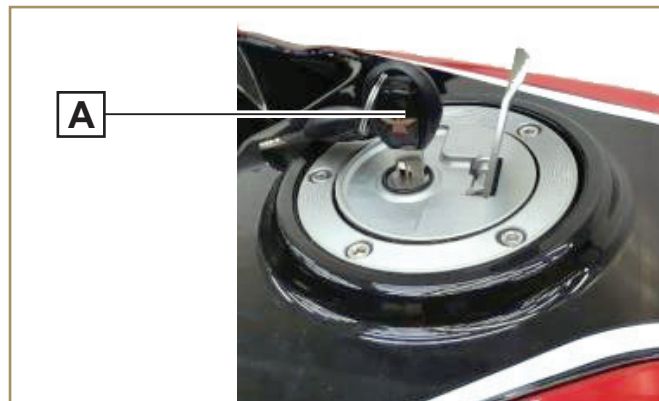

## Passenger Seat lock

### Open the passenger seat

Insert the ignition key and turn it clockwise until the lock clicks into place. You can pull up the rear part of the passenger seat and move the passenger seat backward to remove it.

### Assemble the passenger seat

Insert the hook on the front of the passenger seat under the frame bracket, insert the bayonet into the slot of the frame, and push down the rear end of the Passenger seat until the seat lock makes a "click" sound.

- A. Hook;
- B. Bayonet;
- C. Frame;
- D. Bracket



## Main seat

### Open the main seat

After opening the rear-seat, use a wrench to remove the two bolts, pull up the back of the main seat, and move it backwards to remove it.

### Assemble the main seat

Put the left and right hooks of the main seat into the frame bracket, put the front hook into the fuel tank bracket, push forward the rear part of the main seat, and use a wrench to install 2 bolts;

**A:** Front hook

**B/C:** Side hook

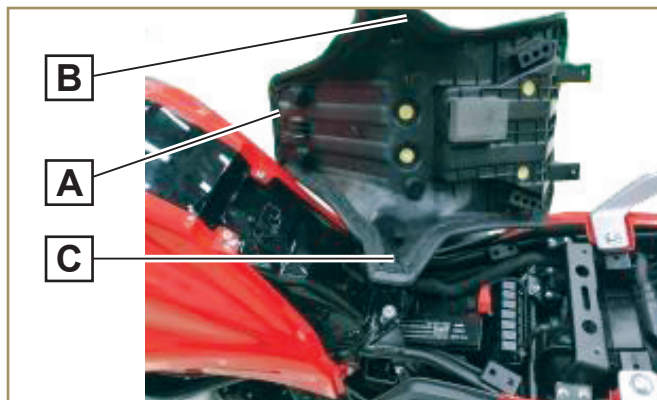

## Dashboard

No.	Instruction
1	Indicator light
2	Vertical menu
3	Tachometer
4	Time
5	Gear indication
6	Total mileage
7	Fuel gauge
8	Horizontal menu
9	Coolant temperature
10	Speedometer
11	Prompt display area

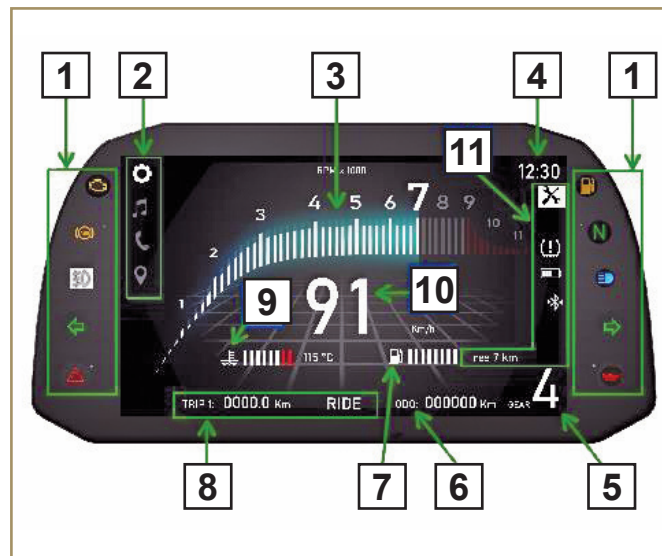











### NOTE

When the ignition switch is turned on, all indicator lights will perform self-checking, and then enter the startup animation.

immediately after, the instrument displays the function operation mode.

## Indicator light(Specific function)

No.	Warning light	Description	State	Instruction
1		Engine warning indicator (yellow)	Turn on	Turn on the ignition switch , the icon should be lit up,
			Flashing	Indicates that the DFI system is malfunctioning. Ask an authorized Moto Morini dealer to check
2		ABS indicator light (yellow)	Turn on	Turn on the ignition switch, the meter will be on after self-check, if you are driving the motorcycle at 5km/h (3.1mph) or higher. The ABS indicator light is off, indicating that the ABS system is normal.
			Turn on	The ABS is malfunctioning. Except for the traditional brake function, ABS does not work. Ask an authorized Moto Morini dealer to check the ABS.
			Flashing	This model is equipped with an ABS turn-off system, which means that the ABS system has been turned off by the customer.
3		Front fog lamp indicator (green)	/	When the current fog lamp is on, the indicator light is on FUNCTION NOT AVAILABLE IN EVERY COUNTRY
4		Left turn signal indicator (green)	/	When the turn signal switch is pushed to the left, the left indicator light flashes.
5		Daytime running light indicator (green)	/	When the daytime running light is on, the indicator light is on

No.	Warning light	Description	State	Instruction
6		Fuel level warning indicator (yellow) 	Turn on	When there is about 4.0 L of available fuel remaining, a red reminder appears on the lowest grid of the fuel gauge and the fuel level warning indicator starts to light up. Please pay attention to refuel as soon as possible. When the vehicle is supported by the side bracket, the fuel level warning indicator cannot accurately display the amount of fuel in the fuel tank. Stand the vehicle upright to check the fuel level.
			Turn on	The fuel gauge has no display segment, the remaining fuel available is about 2.0L, please refuel as soon as possible.
7		Neutral indicator (green)	/	When the transmission is in neutral, the indicator light is on.
8		High beam indicator (blue)	/	When the front light is in the high beam, the indicator light is on.
9		Right turn signal indicator (green)	/	When the turn signal switch is pushed to the right, the indicator light flashes.
10		Oil pressure warning indicator (red)	Turn on	When the oil pressure is dangerously low, or the engine is not running, the ignition switch is "ON" and the indicator light is on. If the indicator light is still on when the engine speed is at normal idling speed or over, stop the engine immediately and check the engine oil level. If the amount of oil is insufficient, add oil. If the amount of oil is sufficient, please check the engine with an authorized Moto Morini dealer.



## NOTE



The situations where the ABS indicator light is always on (yellow) are the following:

1. Start the engine after retracting the side stands, when the rear wheels rotate and the front wheels do not rotate;
2. When using a tire with a different size from the standard, replace the standard size tire;
3. If this happens, please turn off the ignition-switch first, then turn it on again, and drive the motorcycle at a speed of 5km/h (3.1mph) or higher.

The ABS indicator light should go out. If not, please go to an authorized Moto Morini dealer to check the ABS.

## Basic information of vertical menu

The vertical menu has:

1. Setting function
2. Music function
3. Call function

The lit icons can be used to set the corresponding functions, the relevant operation buttons are located on the left-hand switch combination.

The dashboard is designed to use only 4 buttons, corresponding to 3 actions:

1. Select the desired option;
2. Confirm;
3. Exit
4. Triangle switch (▼ or ▲): you can scroll up and down to select various options(A);
5. SET button: confirm the selected option and open the corresponding application(B);
6. BACK button: Exit the option and close the corresponding application(C);

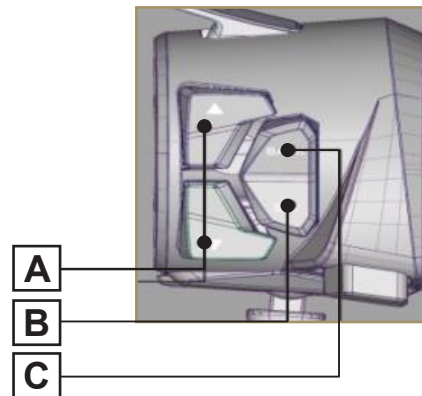

## 1. Setting function menu:

contains vehicle information, device connection, screen display, and system information.



### Vehicle Information:

- Maintenance:** The first mileage for a maintenance intervention is 1000Km; the second maintenance will be carried out at 6000km maintenance will be carried out every 6000Km afterwards. After the oil is changed, the remaining mileage for next maintenance is displayed. When the remaining mileage is 100Km, a maintenance prompt symbol will appear on the main driving interface, prompting the user to perform maintenance as soon as possible;
- Single mileage:** This instrument can record two single mileage records. Here is another single mileage that is different from the riding interface.

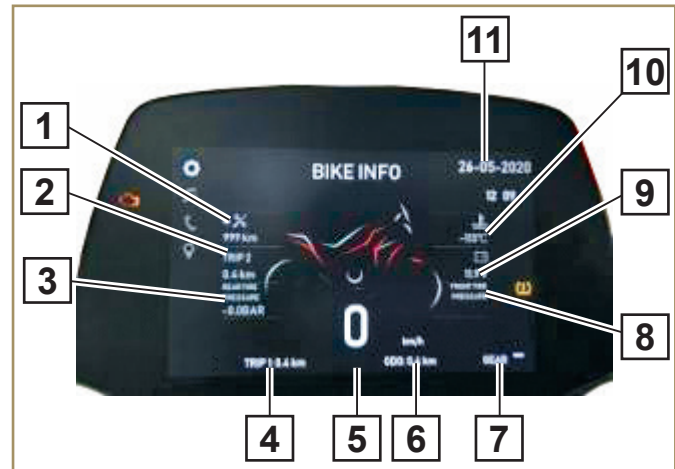

3. **Rear tire pressure:** displays the current value of the rear tire pressure of the vehicle.
4. **Single mileage:** displays the single mileage of the current riding interface
5. **Speed:** Displays the current speed value.
6. **Total mileage:** displays the total mileage of the vehicle.
7. **Gear display**
8. **Front tire pressure:** displays the value of the current front tire pressure of the vehicle
9. **Voltage:** displays the current battery voltage.
10. **Coolant temperature:** displays the current coolant temperature of the vehicle.
11. **Date and time display.**

### **NOTE**

*When the tire pressure is abnormal, please check and repair it with an authorized motorcycle dealer.*

## 2. Device connection



Press ▼ or ▲ to select devices' connection



Press the SET button



Select Earphone 1, press SET button

### Description:

- (a) The device connection function can only be used after the Bluetooth connection between the mobile phone and the dashboard is complete;
- (b) Earphone 1 is the main device, with telephone answering function;
- (c) Earphone 2 is an auxiliary device, which can be selected only when the Earphone 1 device is selected. The operation mode is the same as the selection mode of the Earphone 1, without the call function.



Press ▼ or ▲ to select Bluetooth device, press SET button

## Device deletion



- ✓: To confirm the deletion, press the **SET** button
- ✗: Keep it, press **BACK**

## 3. Screen display: including selection view, brightness

Choose a view:

There are three modes to choose from: Users can choose the view mode according to their driving habits.

1. **Automatic mode:** In this mode, the vehicle can switch between day mode and night mode according to the actual driving conditions.
2. **Day mode:** It is suitable for daytime driving and ensures the best visual visibility.
3. **Night mode:** suitable for driving at night to ensure the best visual visibility.

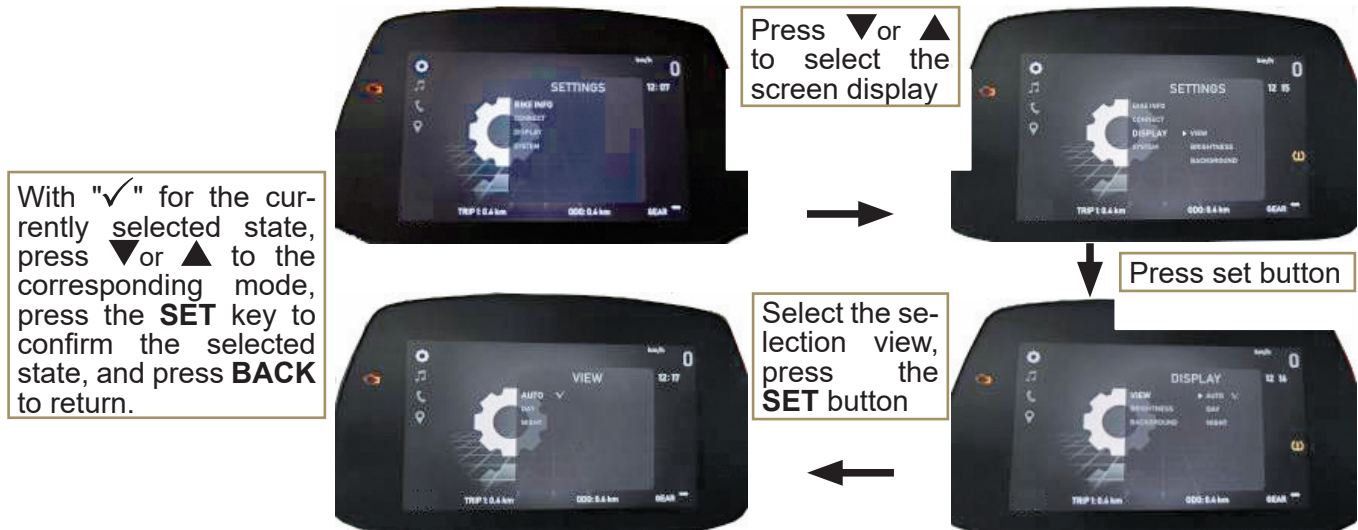

Brightness adjustment: equipped with automatic mode and manual mode.

- 1. Automatic mode:** automatically adjust the screen brightness according to the brightness of the surrounding environment of the vehicle
- 2. Manual mode:** Users can adjust the brightness according to their driving habits. Each time you press ▼ or ▲, the ratio will be adjusted by 5%.



With "✓" for the currently selected state, press ▼ or ▲ to the corresponding mode, press the SET key to confirm the selected state, and press BACK to return. When the manual mode is selected, press the SET button a few seconds, an adjustment bar "75% - [ ] +" appears, press "▲(+)" or "▼(-)" to adjust the brightness.





**Background mode:** Riding mode and off-road mode. In these two modes, different backgrounds of the night view can be switched.

1. **Riding mode:** There are four backgrounds: "ROAD", "PURE", "DIRT" and "NEXT".
2. **Off-road mode:** There are two backgrounds: "PURE" and "DIRT".

### Road background Pure Background Dirt backgroundNext background

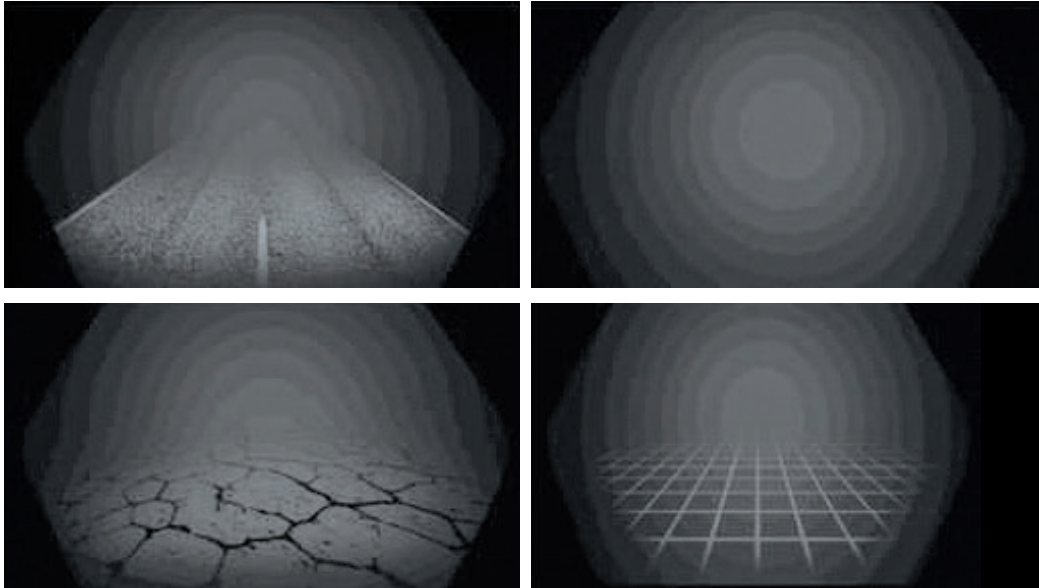

Press ▼ or ▲ to select background mode



Press ▼ or ▲ to select riding mode or off-road mode, press **SET** button, take riding mode as an example.



With "✓" for the currently selected state, press "▲" or "▼" to the corresponding mode, press the **SET** key to confirm the selected state, and press **BACK** to return.

Press ▼ or ▲ to select riding mode or off-road mode, press **SET** button, take riding mode as an example

**4. System information: There are settings for language, unit, and timefunctions.**



Press ▼ or ▲ to select system information



Press the **SET** button

**Language:** There are three languages: Chinese, English and Italian, and users can choose the language they need according to their needs.

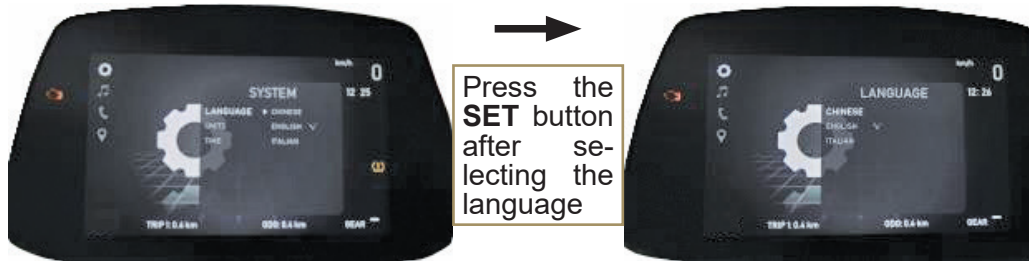

Press the **SET** button after selecting the language

With "✓" for the currently selected state, press "▲" or "▼" to the corresponding language, press the **SET** key to confirm the selected state, and press **BACK** to return.

**Unit:** There are two units : Metric Unit and British Unit. After selection, the main interface will display related values according to the selected unit.



**Time:** Here is an adjustment of time and date.







**Date:** with year, month and day adjustments. Display format: day-month-year

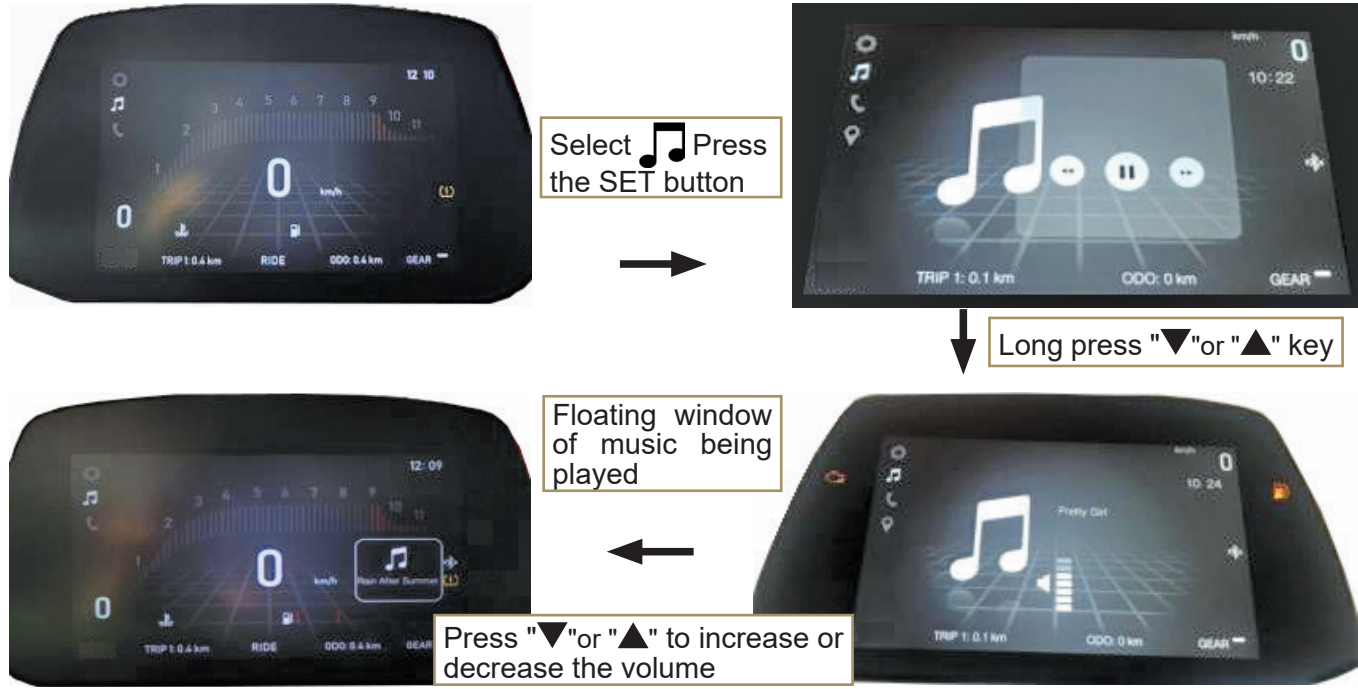

**Music function menu:** When  appears, you can play music through the mobile phone by connecting via Bluetooth(name: X-CAPE-XXXX). Press the "SET" button in the music menu to play and pause, press "▼" or "▲" to go to the previous track or next track. Volume adjustment function: the volume will be memorized after the volume adjustment, and will stay in its position during the next adjustment.



Call function menu: when  appears, you can make a call or answer.

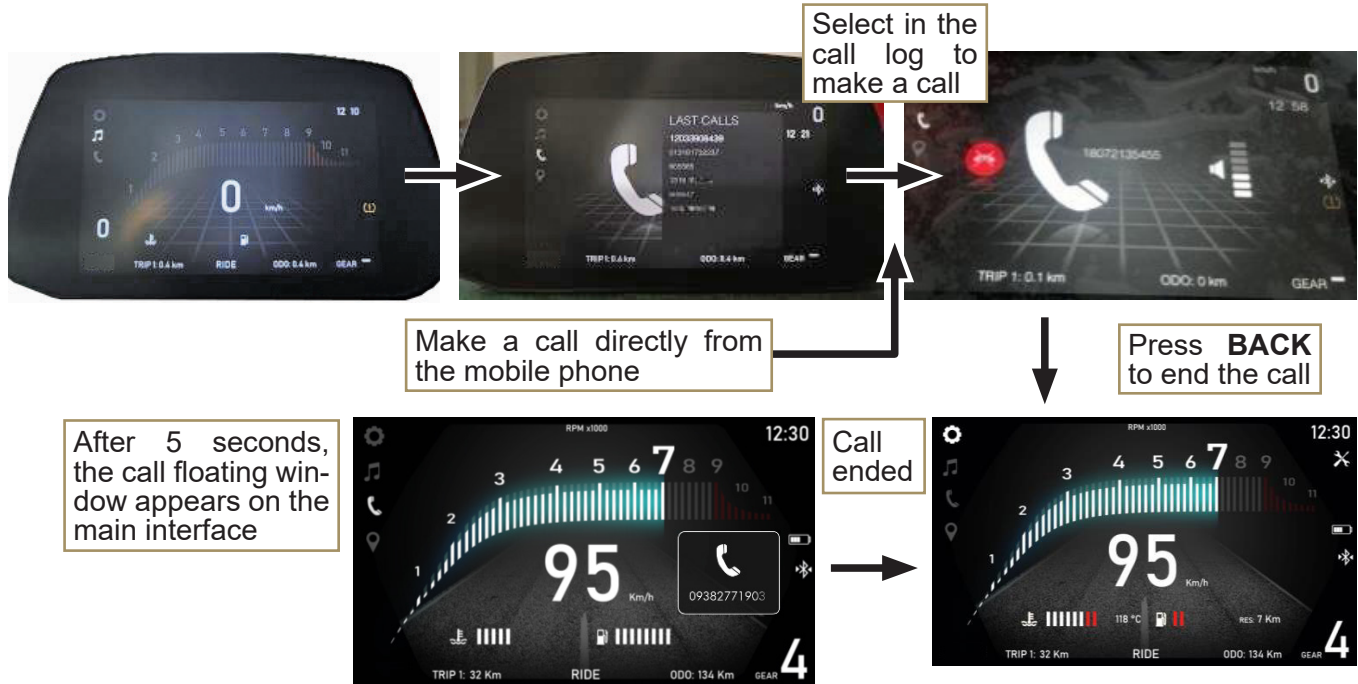

**NOTE:**

Press " " or " " key to increase or decrease the volume



**The navigation menu (specially for China IV):** dedicated APP, built-in navigation map, support background operation. Use WIFI link mode. Scan the QR code for the first time to download and install the APP software.– **not available in every country -**



Press the **SET** key to select



Instrument **WiFi** device name

Scan code link or **WiFi** search device connection, navigation



**NOTE**

The navigation function needs to open the personal hotspot of the mobile phone.



**WARNING!**

During riding, it is strictly forbidden to use the mirroring function in the mobile navigation APP.





### Basic information of horizontal menu

The horizontal menu is equipped with: single mileage setting main interface mode.

**Single mileage:** There are two counts of TRIP1 and TRIP2, and the display range is 0-5999.9Km (3725.9MI). After activation according to the following operations, the single mileage can be reset and option settings can be set according to the user's needs.

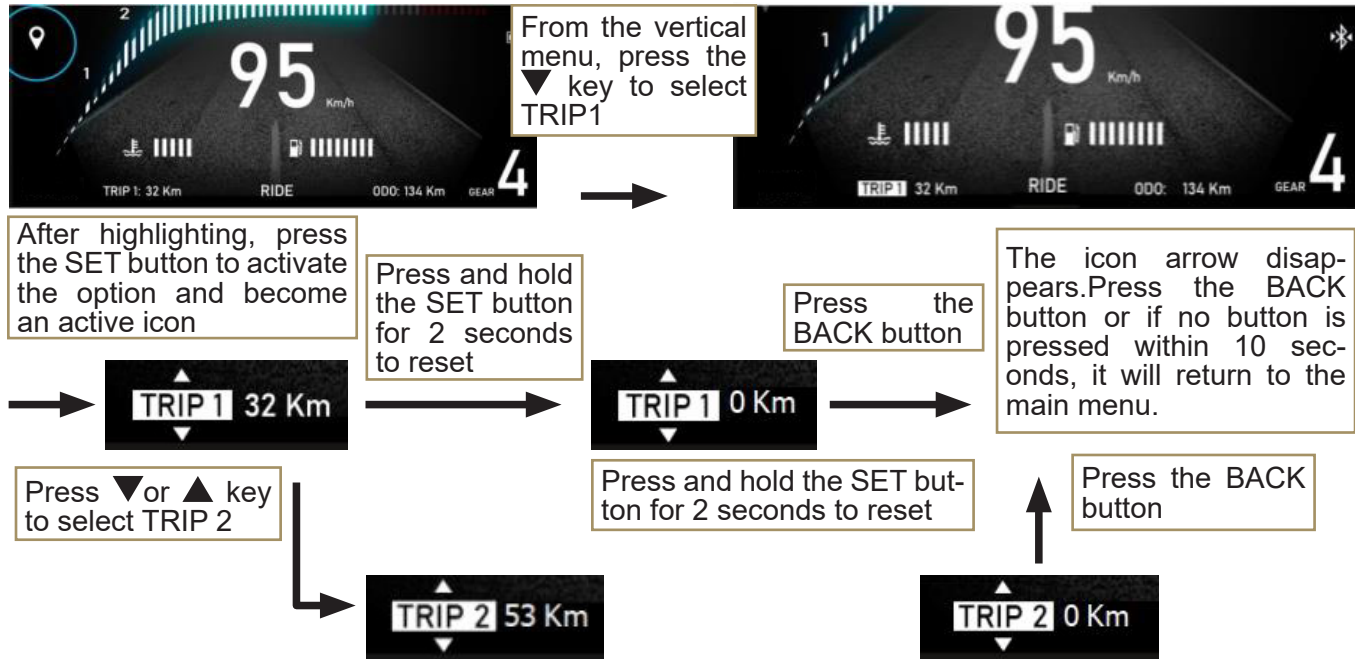

**Interface mode:** divided into riding mode (**RIDE**) and off-road mode (**OFF-ROAD**).



After selecting TRIP, press the **▼**, **RIDE** becomes the icon to be selected and highlighted.



After highlighting, press the **SET** button to activate the option and become the active icon.

The icon arrow in the activity disappears. Press the **BACK** button or if no button is pressed within 15 seconds, it will return to the setting icon .

Press the **BACK** button



Press **▼** or **▲** key to select **OFF-ROAD**



## Basic information of display function

**Time:** The time display changes according to the setting of the unit, divided into 24-hour system and 12-hour system. For the setting method, please refer to the time setting under the system setting under the setting menu. Gear position indication: real-time display of the gear position, the gear position is displayed as "-" and "1-6", and the display as "-" means it is in the neutral state, and the neutral indicator "N" light is on.

**Total mileage:** ODO displays the total distance traveled by the vehicle. The display range is 0-999999Km (620999Mi). When the total mileage reaches 999999Km, it will be reset to 0 Km.

**Speedometer:** The speedometer is digitally displayed and can be set according to km/h or mph. The unit settings should be changed according to local regulations.

Please be sure to set the unit (km/h or mph) correctly before driving.

For the setting method, please refer to the unit setting under the system setting under the setting menu.



Time

**Tachometer:** The tachometer shows the engine speed per minute (revolutions per minute, RPM). The tachometer will be lit up accordingly with the speed, and the corresponding number will become larger at the same time. When the speed is greater than 9000RPM, the display is in the red zone.

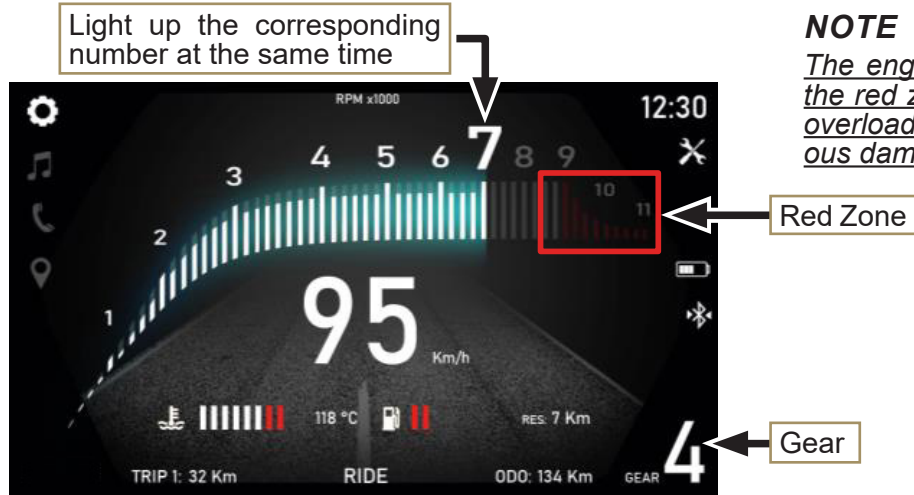

**NOTE**

The engine speed is not allowed to enter the red zone. Running in the red zone will overload the engine and may cause serious damage to the engine.

**Fuel gauge:** The fuel quantity is displayed in eight segments. When the fuel quantity is displayed in one segment, the display will be red and the fuel alarm light will be on. When the fuel gauge has no display segment, the remaining fuel available is about 2.0L. Please refuel as soon as possible.

When the fuel sensor is faulty, the fuel gauge is displayed in red for the first and eighth segments.



Fuel warning light

**NOTE:**

When the fuel warning light is on, please refuel as soon as possible.

**Coolant temperature indication:** display the temperature status of the engine coolant. When the temperature reaches the corresponding value, the display segment will be displayed (see the figure below), When the coolant temperature rises to between 110°C (230°F) and 118°C (244°F), a red warning appears in the display segment to warn the driver that the coolant temperature is too high. When the temperature reaches 118°C (244°F) and above, the second red warning will appear on the display segment and the 118°C temperature display will appear on the screen. At this time, the engine needs to be turned off. After the engine has cooled down, check the coolant level in the storage tank and check whether the cooling

system is faulty. For detailed information about the coolant, please refer to the vehicle information in the setup menu.

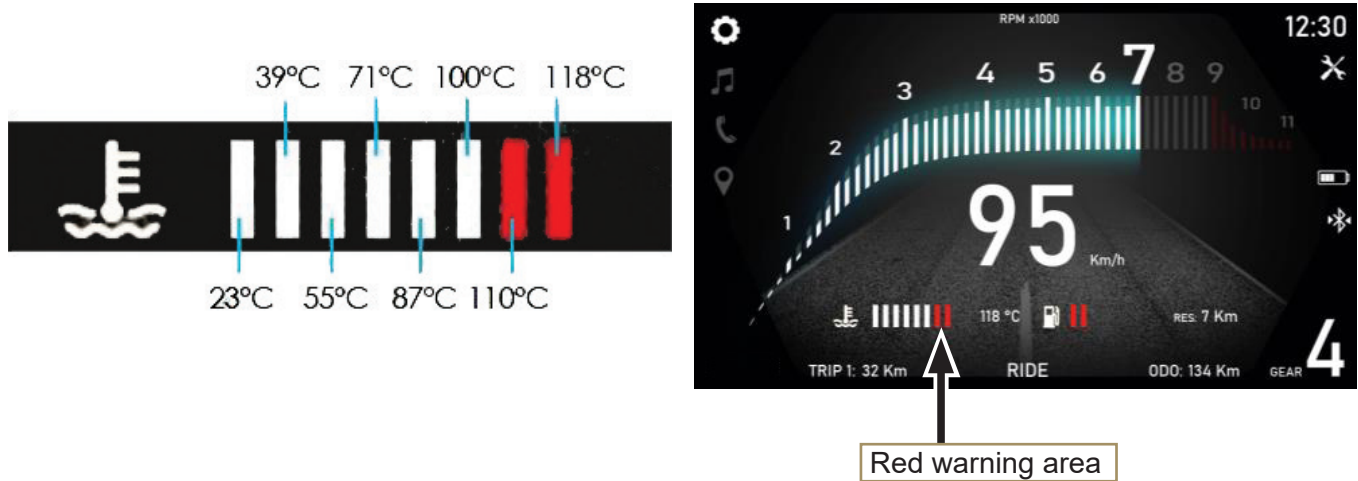

## Basic information of warning function

### Bluetooth:

After the mobile phone is connected to the Bluetooth of the instrument,  will display on the main interface of the instrument, indicating that the connection is normal, and the music and call functions can be performed by pressing the button.

### Maintenance warning:

When the distance to the next maintenance is 100Km, a prompt  will appear on the instrument interface, and the user needs to maintain the vehicle as soon as possible. The first maintenance mileage is 1000Km, and each subsequent maintenance distance is 6000Km. For details of maintenance, please refer to the vehicle information under the setting menu.

### Maintenance reset:

After the user has completed the maintenance of the vehicle, he can press and hold the "▼" and "▲" at the same time until the  symbol disappears, the maintenance mileage in the vehicle information is reset to 6000Km, and the next maintenance mileage calculation starts.

### Tire pressure warning:

When the tire pressure value is not bigger than 180KPa or not less than 320KPa, a yellow  will appear. When the symbol is prompted, the user should check and repair the tire according to the specific situation.

**RESmileage:** Remaining mileage reminder. When the fuel is displayed in two segments, the remaining mileage warning light will be displayed. This mileage will vary due to different road conditions and dif-

ferent driving conditions. This mileage is only for reference and remind users to pay attention to the fuel situation.

## ABS basic information

**Turn off ABS:** Users can turn off **ABS** in the "OFF-ROAD" mode, but users need to use this feature with caution. The shutdown must be operated when the vehicle is stopped. When the user turns off the ABS, a prompt will appear on the main interface, and the warning light () will flash yellow.

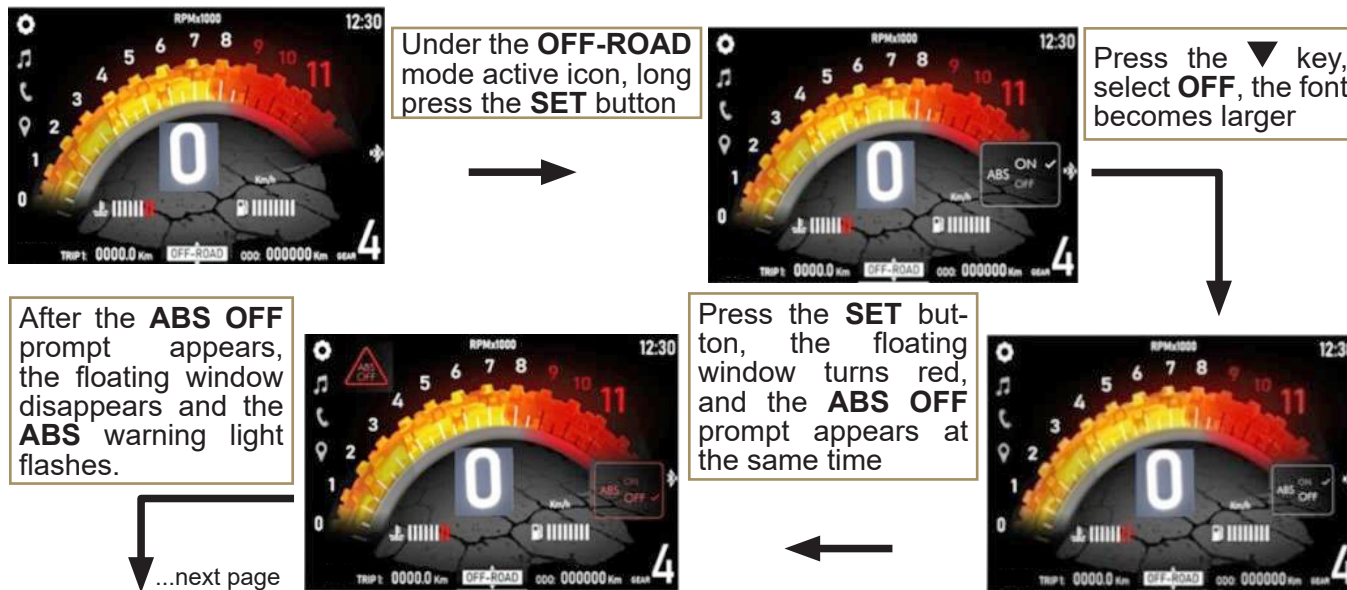



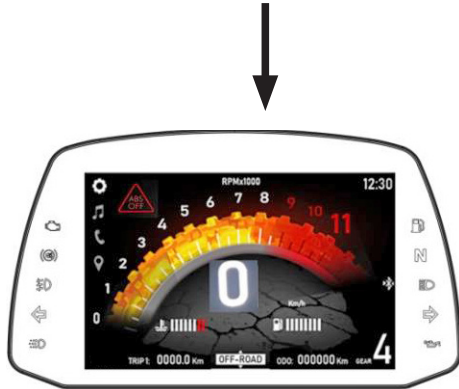

Press the **BACK** button to return to the setting menu or return to the setting menu automatically after 15s without any operation.

## Start of ABS

In any of the following cases **ABS** reactivates:

- A. Turn off the engine and restart the vehicle;
- B. The mode is changed from "off-road mode (**OFF-ROAD**)" to "riding mode (**RIDE**)";
- C. Select "**ABS ON**" from the **OFF-ROAD** submenu.

### 1. "Overtaking(passing) lights" button-

The headlight high beam sends a signal to the driver ahead to warn that the vehicle is about to pass; Release the button and the signal light will be turned off;

### 2. Horn button-

Press the button and the horn starts to work;

### 3. Turn signal button-

When the turn signal light switch is set to the left ( ) or right ( ), the relevant signal lights start to flash continuously. When it stops flashing, push the switch;

### 4. Light switch button-

High beam/low beam, you can choose high beam or low beam by controlling the dimmer switch. When the front light is high beam ( ), the high beam indicator turns on;

### 5. Instrument operation buttons-

refer to the instrument description for relevant information;

Left handlebar switch

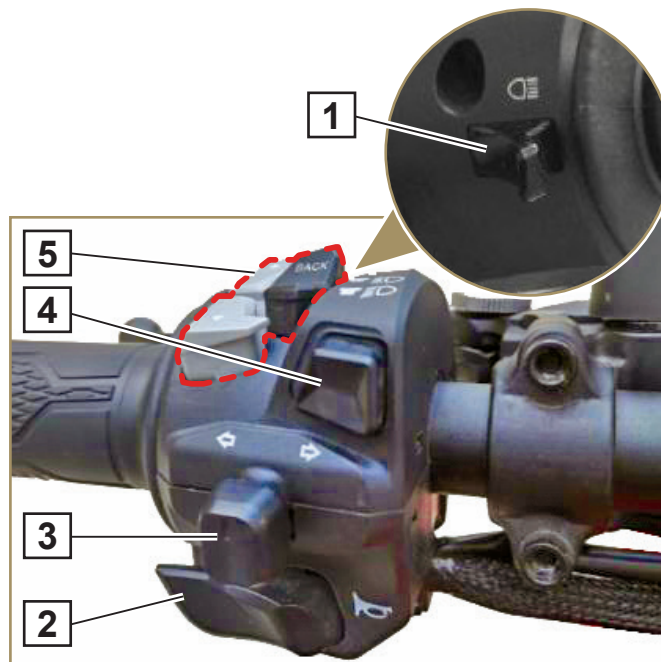

#### **NOTE**

With high beams, all headlights are turned on. When the low beam is turned on, only the two headlights are turned on.

## Right hand switch

### 1. Electric start switch

- (1). When the transmission device is in the neutral state, the start button can control the starter motor; ~~✗~~
- (2). In the non-neutral state, retract the temple bracket, hold the clutch brake handle, and press the start button at the same time to control the starter motor

### 2. Light switch

- (c). The daytime running lights are on;
- (d). Passing beam is ON

### 3. Flameout switch

When set to "↻", the engine is running; the engine shutdown switch is an emergency switch, if necessary, move this switch to the ~~✗~~ position.

### 4. Emergency warning switch

All turn signal lights and turn signal indicator lights begin to flash continuously;

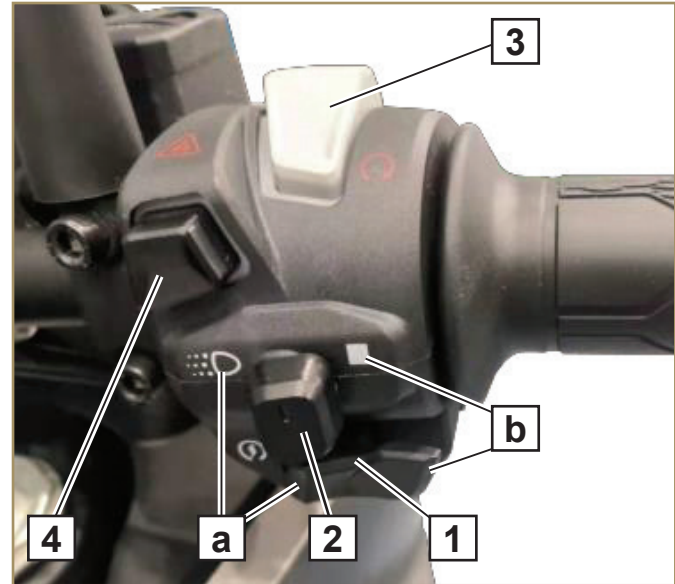

## Clutch lever•

The clutch lever is a switch that controls the clutch.

- Pull the clutch lever (A) toward the handlebar, and the drive from the engine to the transmission (and rear wheels) will be interrupted.



### IMPORTANT

To avoid premature damage to the clutch components, do not pull the clutch lever when the engine is accelerating.

## Distance adjustment

The distance between the clutch handle and the steering handle can be adjusted according to the size of the driver's hand, the thickness of the gloves or other special needs.

Rotate the adjusting screw (B); turn the screw clockwise, and the clutch handle away from the direction handle, rotate the screw counterclockwise, then vice versa.

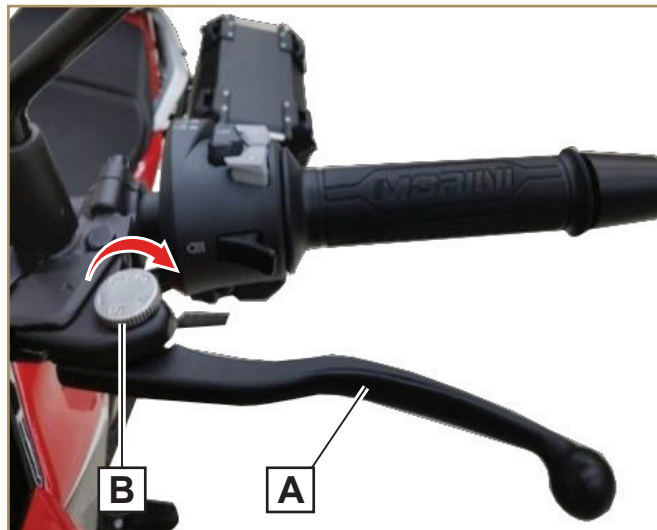

## Front Brake lever

- Pull the front brake lever (A) towards the handlebar to activate the two front brake calipers;

## Distance adjustment

The distance between the brake lever and the steering handle can be adjusted by rotating the adjusting screw (B) according to the size of the driver's hand, the thickness of the glove or other special needs or riding habits; Turn the screw to the brake pump side, and the lever keep far away from the handlebar, and the opening will increase; on the contrary, the opening will decrease;

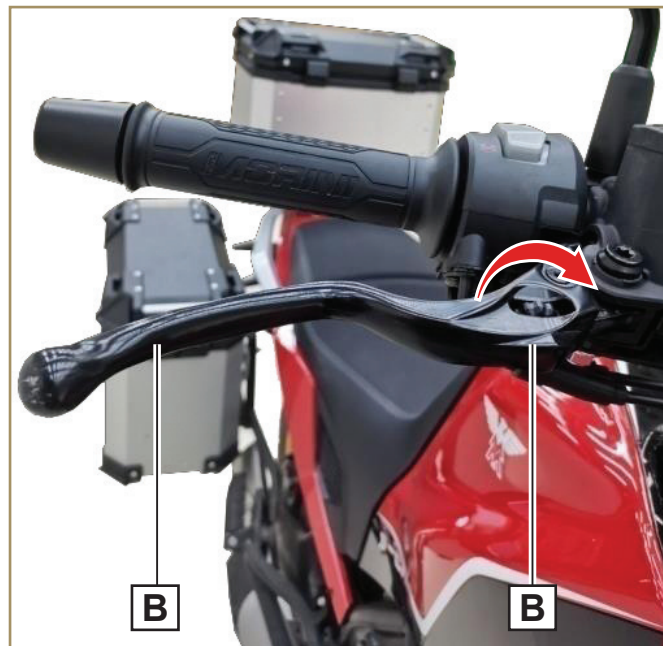

## Throttle Cable control

The clutch handle device is located on the left side of the handlebar to control the opening angle of the clutch stroke.

### Adjusting the throttle Cable

The throttle cable can be adjusted through the expansion and contraction of the cable.

- Loosen the ring nut (A).
- Adjust the effective working length of the throttle cable by rotating the adjuster (B);
- Tighten the ring nut (A).

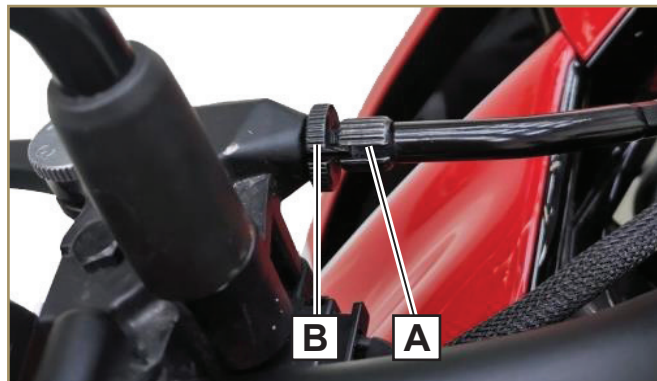

**NOTE**

Adjust to the best condition of the vehicle according to personal driving habits.

**NOTE**

Do not over-stretch the throttle cable to avoid changing the idling speed of the engine.

**NOTE**

Excessive free clearance or no free clearance at all may cause the throttle control cable to loosen.

## Front fork

### NOTE

The front fork is set according to the driver's weight of 75 kg at the factory, and can be adjusted according to actual conditions or special riding requirements during actual use.



## INTERVENTIONS

### Spring preload

The spring preload (for the two front forks) is set by the adjuster (A).

- Tighten (clockwise) to increase preload.
- Loosen (counterclockwise) to reduce preload.
- The standard value is **2 TURNS CLICK CLOCKWISE FROM FULLY OPEN SETTING.**

### NOTE

The left front fork and the right front fork must be adjusted in the same way.

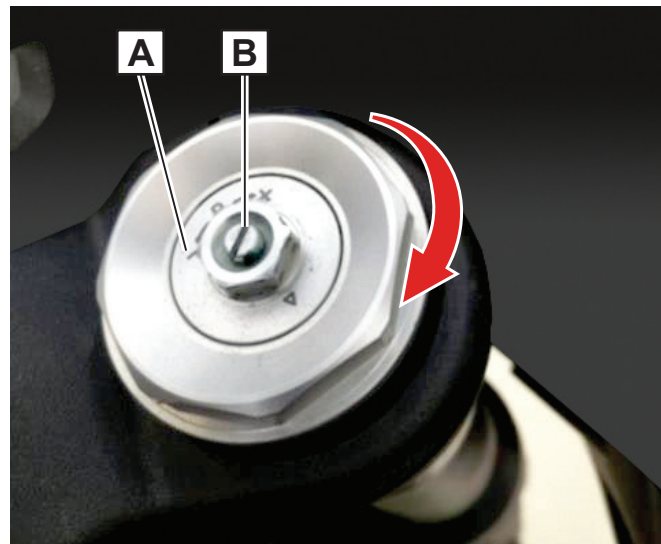



### **Compression damping (adjustment (B)-left fork)**

- The compression rate can be adjusted by the adjustment screw (B) on the left end. Turn counterclockwise from the full initial position of the adjuster to adjust the damping.
- The compression rate can be adjusted by the adjustment screw (B) on the left end.

#### **NOTE**

Turn the adjustment screw (B) clockwise to reduce the compression rate (the suspension becomes stiffer). The standard position is 4 **TURNS COUNTERCLOCKWISE FROM FULLY CLOSED SETTING.**

### **Rebound damping (adjustment (B)-right)**

- The rebound rate can be adjusted by the adjustment screw (B) on the end.

#### **NOTE**

Turn the adjustment (B) screw clockwise to reduce the rebound rate (the suspension becomes stiffer). The standard position is 3 **TURNS COUNTERCLOCKWISE FROM FULLY CLOSED SETTING.**

## Rear shock absorber

• The rear shock absorber is equipped with an external regulator to set the shock absorption parameters according to different load conditions.

### NOTE

The factory default setting of the rear shock absorber is calibrated based on a riding weight of 75 kg.



## INTERVENTIONS

### Spring preload adjustment

- The spring preload adjustment plates (A and C) are located under the driver seat on right side. Use it to adjust the spring preload, as shown below:
- Tighten (clockwise) to increase preload;
- Loosen (counterclockwise) to reduce preload.

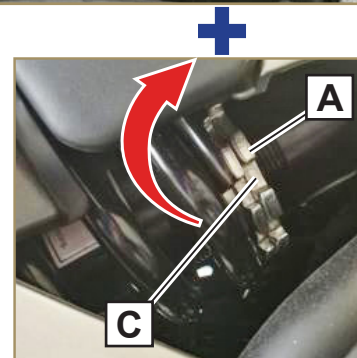
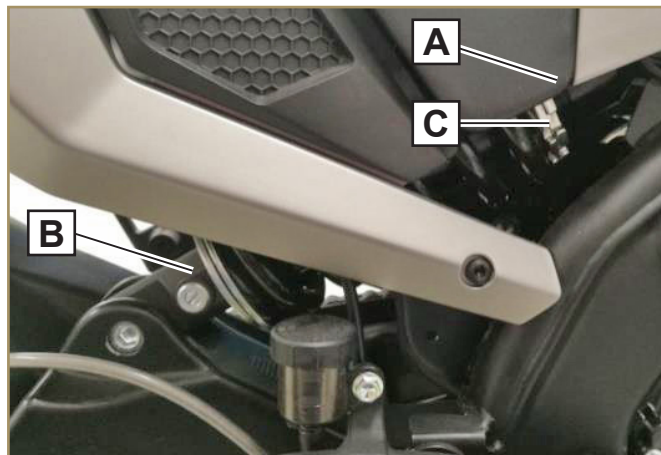

## Rebound adjustment

- Use the adjusting screw(B) to adjust the rebound speed of the rear shock absorber.
- Turn the screw clockwise to gradually reduce the rebound speed.
- Turn the screw counterclockwise to gradually increase the rebound speed.
- The standard position is 12 **CLICKS COUNTER CLOCK WISE FROM FULLY CLOSED SETTING**; the compression resistance is not adjustable.

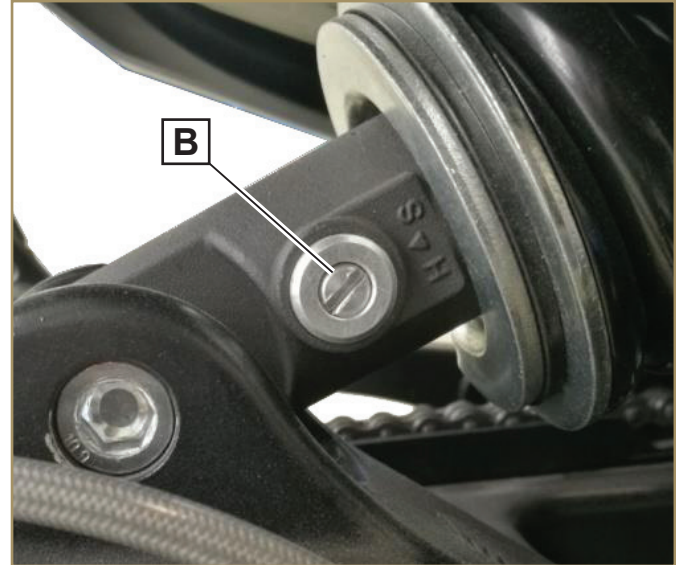

## WARNING!

After making any adjustments to the suspension, it is recommended to drive at a low or medium speed first to be familiar with the driving experience of the newly set vehicle.

## **Gear shifting lever**

- Every time the shift lever pedal (A) moves up and down corresponding to engaging different gears (one gear at a time).

## **Start**

- a. Check whether the side stand is in place;
- b. Pull the clutch handle;
- c. Stepping down the shift lever pedal (A) to switch to gear 1;
- d. Open the throttle handle, give the engine enough fuel to avoid stalling, and slowly loosen the clutch handle.

## **Gear shift:**

- a. Loosen the throttle handle and pull the clutch handle;
- b. Pull up or step on the shift lever pedal to switch to a higher or lower gear;
- c. Turn the throttle handle and release the clutch handle at the same time.

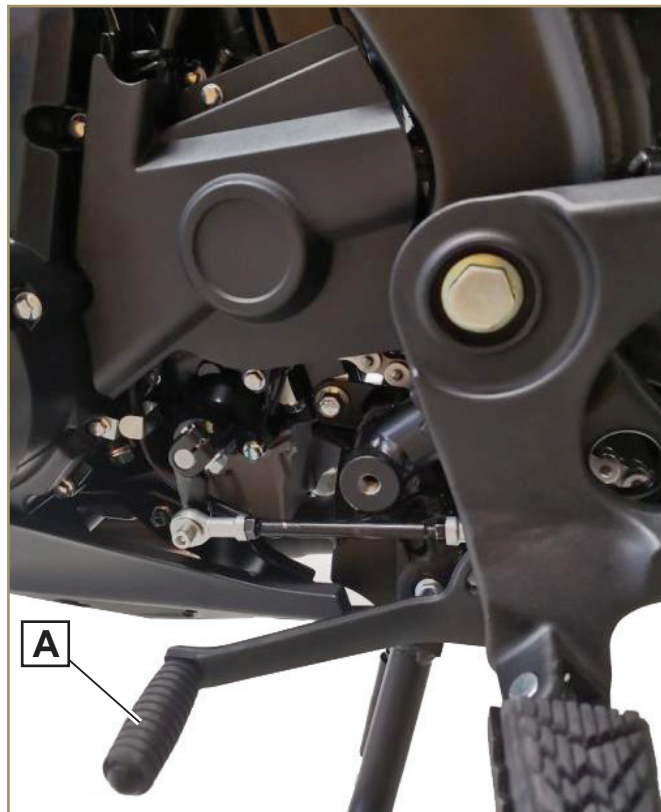

## Position adjustment

- The shift pedal can be adjusted according to the requirements of the rider.

The adjustment method is as follows:

- Use a wrench to loosen the nut (c) and nut (d);
- Operate the adjustment lever to decrease or increase the length according to actual needs;
- Sit in the main seat to check if it is in the right place.

Tighten nut (c) and nut (d) completely.

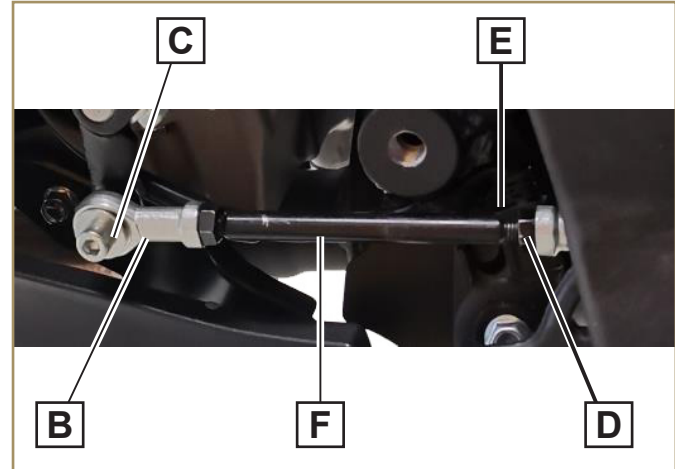

## Rear Brake Pedal

The rear brake is activated by hydraulic pressure on the pedal.

- Loosen the throttle handle completely and step on the brake pedal (except when shifting gears) to reduce the speed of the motorcycle;
- When braking, the front brake handle and rear brake pedal should be used at the same time. The frequency of use of front brake is generally higher than that of rear brake;
- Do not lock the brakes, otherwise the tires will slip. When turning, please reduce the speed first and try not to brake;
- During emergency braking, no need to down-shift.



## Adjust the position of the rear brake pedal

- Adjust the ground clearance of the rear brake pedal by loosening the lock nut (A) and operating the adjuster (B) until the brake lever reaches the desired position.
- Sit on the seat and check the position.
- Tighten the lock nut (A).
- The rear brake pedal can only lower the height.

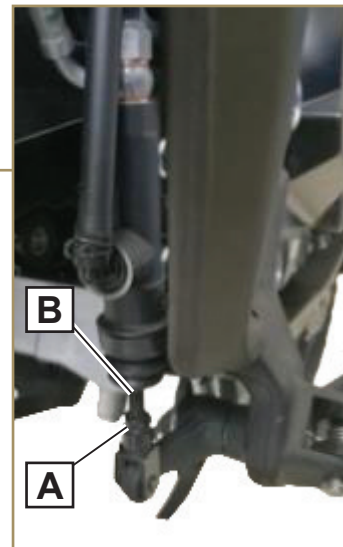

## Side Stand



### IMPORTANT

Before operating the side stand, check the consistency and uniformity of the inclined surface. Lawn, muddy or rugged terrain, softened asphalt and other ground can cause the motorcycle to tip over and cause serious damage;

If it is a steep slope, park the motorcycle with the front wheel facing up;

When lateral inclination or bumps occur, park the side stand on the most possible flatroad;

Regularly check whether the spring return and the safety sensor (A) are working properly;



### WARNING!

Do not sit on the seat when parking the vehicle with side stand.

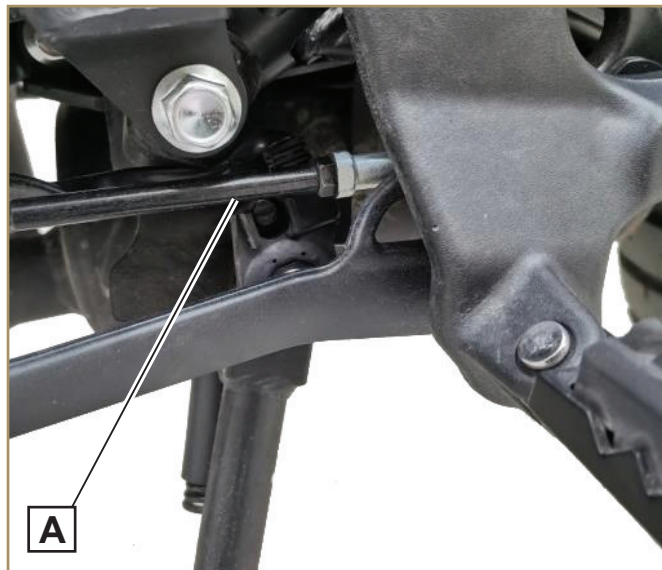

## Tires

Type: **Tubeless tire**

- Front 110/80R19 M/C(59H) TL;
- Rear 150/60 R17M/C(69V) TL.

	Tire pressure(bar)	
	front	rear
Only driver	2.4	2.5
With passenger	2.4	2.9



### **NOTE**

Check and restore tire pressure with cold tires.



**IMPORTANT**

In terms of load (that is, the total weight of the motorcycle), sufficient tire pressure is an extremely important factor to ensure safe driving.

**IMPORTANT**

Check the condition of the tires every time you drive. Whenever there are cuts, cracks, bulges, etc., the tires should be replaced immediately. When the tire tread is worn out, the tire becomes easy to puncture and malfunction; tire tread marks are an important reference for tire replacement.

**WARNING!**

In order to ensure safe and stable driving, please use the recommended standard tires and rims, and inflate the tires to standard pressure.



## Fuel Tank

### Refueling

- Only after stopping the engine and placing the motorcycle on the side stand can allow to open the fuel tank cap.
- Do not smoke or start the engine when refueling.

Fuel tank	Liters
Total volume	18
Fuel reservoir	4



### IMPORTANT

Immediately wipe off the fuel spilled from the fuel tank or other parts of the motorcycle.



## Terms of use



### **WARNING!**

- The owner of the motorcycle is personally responsible for maintaining the best condition of the motorcycle.
- Improper maintenance, long-term non usage and exposure to bad weather can cause serious damage and threaten the lifespan and performance of the motorcycle.
- Leaking of fuel tanks or flat tires can cause serious consequences. Therefore, it is very important to thoroughly inspect the motorcycle and its main components before use.
- If the motorcycle is not operating normally, the driver must stop immediately and turn off the engine.
- Contact the affiliated service center and/or road assistance.

## Run-in (1,000 km)



### IMPORTANT

Good running-in is essential to the service life of all moving parts to ensure their long-term normal operation. During the running-in period, it is recommended not to drive with the throttle control lever always in the same position.



### WARNING!

Remember to perform the first maintenance after driving 1000 kilometers.

**Check items before use**

Description	Check
Fuel	Remaining quantity
Engine oil	Optimal liquid level and no leakage
Coolant	Optimal liquid level and no leakage
Tires	Pressure-wear-potential damage
Steering	Free rotation in both directions
Suspension	Adjustment and no leakage
Brake	Operation-wear-no leakage
Chain	Proper tension and lubrication
Throttle control	Please control the throttle gently, without unnecessary operation, lubricate and adjust if necessary.
Lights and indicator lights	Check whether the operation is correct.

## **Riding skills**

- Let the engine idle for a few minutes before riding;
- Do not let the engine idle for a long time;
- Do not start the engine indoors or in a poorly ventilated space. Exhaust gas is extremely toxic;
- Don't accelerate too fast when starting, and don't turn the throttle handle suddenly;
- When turning or changing lanes, always use direction indicators to indicate ,etc.;
- Do not accelerate when the brake is working;
- Under normal road conditions, it is best to use the front brake;
- After long-distance driving in hot weather, it is recommended to run the at engine idle for a few minutes before stopping.

## Safety precautions for the first use of motorcycles

Until the mileage does not exceed 800 kilometers-in all gears, do not exceed 5500 rpm.



### IMPORTANT

It is recommended to change the engine speed frequently without exceeding the specified limit. It is also recommended to check the chain tension and lubrication frequently.



### IMPORTANT

To ensure that the friction materials (brake pads and brake discs) run in correctly, excessive and prolonged braking should be avoided. The mileage from 800 kilometers to 1000 kilometers 7500 rpm in all gears should not be exceeded.



### IMPORTANT

After reaching the first 1,000 kilometers, go to a MOTOMORINI authorized service center for the first inspection.

## Info before start



### IMPORTANT

Before starting the engine for the first time, be familiar with the control operation, because every action must be smooth and without any interference.

**WARNING!**

Never start the engine indoors. Exhaust gas is highly toxic and may cause coma and death.

**Start the engine**

- As long as the engine is in neutral gear and the clutch lever is pulled, the engine can be started with the side stand down;
- To start the engine when it is in gear, you must pull the clutch lever and retract the side stand;
- Do not turn the throttle handle.

**NOTE:**

The engine start does not require any manual cold start device. The electronic control unit manages the engine start and automatically determines the most suitable idle speed according to the temperature, humidity, atmospheric pressure and the internal temperature of the engine.



## Engine Start

- Turn the key to the "on" position;
- Turn on the emergency flameout switch to the operating position (C);
- Press the start button (B) to start the engine within 5 seconds, if the engine fails to start within 5 seconds, please release the start button, press the start button again after 3 seconds, and repeat the above actions.

### NOTE

If the engine fails to start within 3 times, please check the battery level.

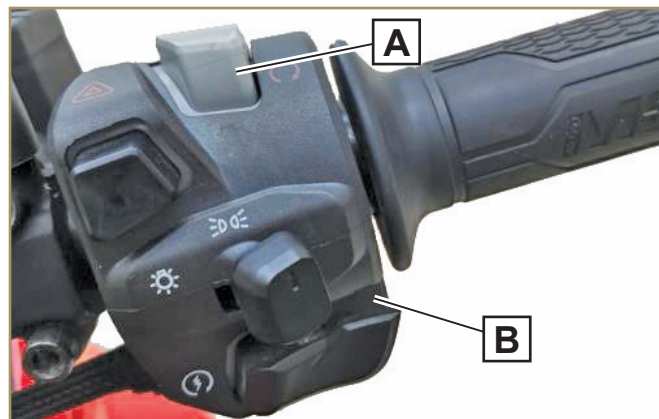

## IMPORTANT

A few seconds after the engine is started, the oil pressure warning light will automatically go out. If the indicator light is still on, immediately turn off the engine and check the oil level. If the oil level is correct, please contact MOTO MORINI Service Center



## IMPORTANT

Do not run the engine at an excessively high speed. The oil must gradually heat up in order to reach all parts that need to be lubricated.



## WARNING!

When the engine is started, the warning light (ABS) is on. If it exceeds 5km/h, the warning light is off.

If the light stays on, stop the engine immediately and restart the motorcycle. If the warning light does not turn off, please contact a Moto Morini Authorized Service Center.

It is recommended to keep the **ABS** system on at all times. However, **ABS** (anti-lock braking system) can be disabled. To disable the anti-lock braking system, follow these steps:

- Put the motorcycle steady.
- Insert the key into the ignition switch and turn on the dashboard.

The menu option of the instrument is **ABS OFF** (refer to the chapter "ABS Basic Information"), the **ABS OFF** prompt appears on the instrument panel, and the LED light flashes at the same time;

## NOTE

The slowly flashing LED indicates that ABS is disabled.

To restart the ABS system, please refer to the chapter "ABS Basic Information"; at the end of the program, the LED will remain off.

## Acceleration

- As mentioned earlier, after starting the engine, run it at idle speed for a few minutes. To start, fully pull the clutch handle and step on the shift lever firmly to enter the first gear.
- Slowly release the clutch handle while gradually accelerating;
- To shift to second gear, release the throttle , pull the clutch lever, lift the shift lever with your front foot, release the clutch lever, and accelerate at the same time. Use the same procedure for all other gears. To downshift, release the throttle control, pull the clutch lever, give oil instantaneously to synchronize the gearbox sprocket, then engage the lower gear and release the clutch lever.



### IMPORTANT

On winding roads, such as mountain roads, when the engine speed decreases, downshifts should be carried out in time according to the vehicle speed.

## **Deceleration and Braking**

- Except for sudden obstacles, the brakes must be used gently to avoid locking the wheels and prevent the motorcycle from losing control.
- Decelerate by shifting gears and using engine brakes, and then adjust the braking force by using two brakes.
- On slippery or bumpy roads, roads with holes, poorly repaired roads, granular debris, etc., it must be adjusted to the corresponding mode. In fact, in this case, the traction will undoubtedly be affected, so the brakes must be used carefully.
- On long and steep slopes, shift gears and rely on the braking ability of the engine. Use the brake briefly; continuous use will inevitably cause the friction material to overheat, which will reduce the braking efficiency.

## **Stop the vehicle**

- Turning off the throttle control will cause a gradual deceleration. While operating the clutch lever, downshift and set the gear to neutral (between 1st and 2nd gear), and then use the brake to stop the motorcycle.

**IMPORTANT**

When the engine is off, do not leave the key in the vehicle to avoid damage to the electrical components.

**Parking the vehicle.**

- Put down the side stand of motorcycle;
- Lock the steering lock;
- Do not park the motorcycle near heat sources;
- When parking for a short time in low visibility conditions, please keep the parking light on;
- Do not leave the light on for a long time to avoid draining the battery;
- Do not leave the ignition key in the vehicle, and do not leave the motorcycle unattended, even for a few minutes;
- Do not park the vehicle on dry leaves, plastic materials or wooden surfaces, because the high temperature of the silencer with catalytic may cause fire;
- Do not park your vehicle under a tree. In some seasons, resin residue, fruits or leaves may fall off the tree. These elements may contain chemicals that can damage paint and plastic parts.

## General cleaning



### **IMPORTANT**

- Do not wash the motorcycle immediately after use. Water that evaporates in close contact with hot surfaces may cause stains;
- Do not wash the motorcycle under direct sunlight, especially in summer, because the wash liquid may dry out before rinsing, resulting in damage to the paint;
- Avoid high-pressure water or high-pressure air from entering electrical components, vents, edges of exhaust silencers, instrument panels and handle controls.

**IMPORTANT**

If the engine parts are very dirty, please use a specific degreasing product. Avoid contact with painted parts, chains, sprockets, brake discs, etc. When cleaning plastic and rubber parts, never use solvents or diluents.

**NOTE**

In order to maintain the gloss of painted and metal parts, if the motorcycle is used under the following conditions or situations, it should be cleaned regularly: atmospheric pollution, high atmospheric salinity and humidity, contact with salt or deicing products used in winter. Pay attention to whether there are industrial powder residues, tar stains, dead insects, etc. on the motorcycle body.

To remove dirt on painted parts, use a low-pressure water jet to moisten thoroughly, and remove dirt with the help of a soft sponge and vehicle wash liquid. Always use high-quality organic products and avoid harsh cleaners and solvents. Rinse with clean warm water and carefully dry all surfaces with a deerskin cloth.

**WARNING!**

After cleaning, the brake may not work properly. Because there is water on the friction surface of the brake system, it may temporarily affect the braking, and the brake disc must be cleaned with a special cleaning agent for motorcycles (oil-free solvent).

## Long-term parking

Before storing the motorcycle for a long time, such as in winter, do the following:

- General cleaning
- Raise the motorcycle so that the tires can be lifted from the ground and deflate.
- Remove the battery, the battery must be charged periodically (check and recharge every month).

Cover the motorcycle with a suitable cover to protect the vehicle paint and prevent moisture.



## Maintenance

In order to keep the motorcycle in good running condition, regular maintenance must be carried out in accordance with the maintenance chart;

### 1. Periodic inspection

Regular replacement items	period every ↓	* Total mileage display Km/miles						
		Whichever comes first →						
		1000 600	6000 3700	12000 7400	18000 11100	24000 14800	30000 18500	36000 22200
Air filter element-cleaning				●		●		●
Valve clearance-check	42000 km 25900 mi							
Throttle system (clearance, flexible return)-check	1year	●		●		●		
Idle speed-check		●		●		●		●
Fuel leak (fuel pipe)-check	1year	●		●		●		●
Fuel pipe damage-check	1year			●		●		●
Fuel pipe installation-check	1year	●		●		●		●
Throttle valve body-cleaning.				●		●		●
Coolant volume-check.		●		●		●		●
Coolant leak-check.	1year	●		●		●		●

Damage to radiator and pipeline-check.	1year	●		●		●		●
Radiator and pipeline installation-check.	1year	●		●		●		●
Intake system damage-check				●		●		●
Clutch and drive chain								
Clutch operation (clearance, engagement, disengagement)-check		●		●		●		●
Transmission chain lubrication-inspection#	600 km 100 mi							
Transmission chain tightness-check#	1000 km 600 mi							
Wear of transmission chain-inspection#				●		●		●
Wear condition of transmission chain guard-check				●		●		●
Wheel rim and tire, sprocket seat bearing								
Tire pressure-check		●		●		●		●
Rim/tyre damage-check				●		●		●
Tire surface wear and abnormal wear-check				●		●		●
Rim bearing damage-check	1year			●		●		●
Pedal-Lubrication		●		●		●		●
Sprocket seat bearing-check				●		●		●
Braking System								

Brake fluid leakage-check	1year	●	●	●	●	●	●	
Damage to the brake fluid pipe-check	1year	●	●	●	●	●	●	
Brake pad wear-inspection#			●	●	●	●	●	
Brake fluid pipeline installation-check	1year	●	●	●	●	●	●	●
Brake fluid volume-check	6 months	●	●	●	●	●	●	●
Brake control (braking force, clearance, flexible action)-check	1year	●	●	●	●	●	●	●
Brake light switch operation-check		●	●	●	●	●	●	●
Damping								
Front fork/rear shock absorption (smooth cushioning)-check				●		●		●
Front fork/rear shock absorber hydraulic oil leakage-check	1year			●		●		●
Control system								
Steering clearance-check	1year	●		●		●		●
Steering Bearing-Lubrication	2 years					●		
Electrical system								
Light and switch operation-check	1year			●		●		●
Headlight-check	1year			●		●		●
Temple flameout switch operation-check	1year			●		●		●



# X-CAPE 650

Engine flameout switch operation-check	1year			●		●		●
Chassis								
Chassis Parts-Lubrication				●		●		●
Bolt and nut torque-check		●		●		●		●

## Regular replacement

Regular replacement items	period every ↓	* Total mileage display Km/miles				
		Whichever comes first →				
		1000 600	12000 7400	24000 14800	36000 22200	48000 29600
Air filter element#			●	●	●	●
Engine oil#	Every 6000 km / First 1000 km					
Oil filter	Every 6000 km					
Fuel pipe	4 years					●
Coolant	2 years				●	
Radiator, pipeline	2 years				●	
Brake fluid line	4 years					●
Brake fluid (front/rear)	2 years			●		●
Brake pump rubber seal	4 years					●
Spark plug			●	●	●	●
Sprocket seat buffer block			●	●	●	●

## Daily maintenance

These maintenance tasks must be considered and must be strictly performed by the owner; the long life and performance of the motorcycle depend to a large extent on these operations.

### NOTE

Routine maintenance operations are usually carried out by the owner, but often require sufficient technical training and specific tools; if in doubt, it is recommended to contact the MOTOMORINI authorized service center, which will provide safe and competent services.

Before starting any maintenance work or inspection, place the motorcycle on a flat, solid ground in a well-ventilated protective space, and check whether the engine and exhaust system are sufficiently cooled to avoid spontaneous combustion.



## INTERVENTIONS

The maintenance operations marked with this symbol are the exclusive rights of authorized personnel and must be done in the MOTOMORINI authorized service center;

If these rules are not followed, the manufacturer will waive all responsibilities and claims and will invalidate the warranty (if it has not expired), as this is considered a "vehicle modification". MOTOMORINI also does not encourage you to perform these operations yourself, because they may cause serious damage or death.

## Engine oil

Check liquid level per km: 1,000

- The oil level must be checked for cold or warm engines; if the engine is overheated, wait a few minutes for the oil to stabilize in the oil sump.

Keep the motorcycle perpendicular to the ground.

- The liquid level can be checked from the view glass and is correct when it is in the middle of the window.
- If the liquid level is lower than the center line of the indicator, fill it from the upper filling port (T).
- Oil: 10W40-SN grade fully synthetic motor oil 



## **NOTE**

Check the oil level before a long trip.

## **NOTE**

If you use a funnel or similar tool when filling engine oil, please check whether it is clean; foreign matter or water entering the engine may cause serious damage.

- After the filling is completed, close the filling port cover, start the engine and let it run at idle speed for a few minutes, check whether there is no oil leakage, after a few seconds, whether the warning light on the dashboard is off. Otherwise, please stop the engine and perform necessary inspections.
- About three minutes after turning off the engine, check the oil level again.



## **WARNING!**

Do not mix different incompatible oils to avoid damage to the engine. If there is no recommended engine oil, please use a compatible engine oil. The oil compatibility can usually be checked on a specific chart at a gas station or specialty store.

MOTOMORINI is not responsible for any damage caused by the use of oil with different characteristics from the recommended oil.



## Brake fluid

Brake fluid DOT4.0 **□ - BASF**



### IMPORTANT

Under normal braking conditions, check every 10,000km

Brakes are the most important component to ensure driving safety, and they must always be in perfect condition. Both wheels of the motorcycle are equipped with hydraulic disc brakes.



### WARNING!

Brake fluid and clutch fluid are extremely corrosive and may cause serious injury to the owner and damage the motorcycle. The liquid level must always be higher than the "min" indicator displayed on the two liquid storage tanks. Too low brake fluid level may result in low efficiency of the braking system.



### IMPORTANT

Be sure to use the recommended liquid taken from an unopened container. Be careful not to let foreign objects, water, etc. enter together with the liquid. If the oil brand needs or must be changed, the entire system must be drained. This operation can only be performed by authorized personnel.

Never mix different and possibly incompatible liquids.

## Liquid level check

### (Brake fluid)

- Lean the motorcycle to let the liquid be placed horizontally.

Liquid level indicator:

- (A) Observation port of front brake pump oil cup;
- (B) Mark of rear brake pump fluid;
- **Front brake:** Check the front brake by observing the viewing window of the front brake oil cup A.

Whether the amount of brake fluid in the oil cup is on the lower scale line B.

- **Rear brake:** Check whether the amount of brake fluid in the rear brake oil cup C is on the upper scale line (max).

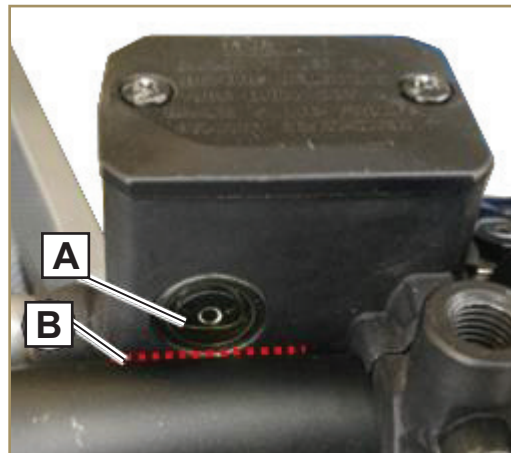

## WARNING!

If the brake fluid decreases, do not use the motorcycle, do not fill up the brake fluid, and immediately contact the Moto Morini Authorized Service Center.

## Coolant

- The auxiliary water tank (A) is located on the side of the fuel tank.

Liquid level check:

- The coolant level in the auxiliary water tank must be checked when the engine and the motorcycle are perpendicular to the ground.

## NOTE

Engine must be cold.

- The correct liquid level is between the "F-L" indicators, which can be seen on the outer surface of the fuel tank on the left side of the motorcycle.
- The cover (B) must be removed for any liquid filling.

Coolant type: **GLYSANT G40** 

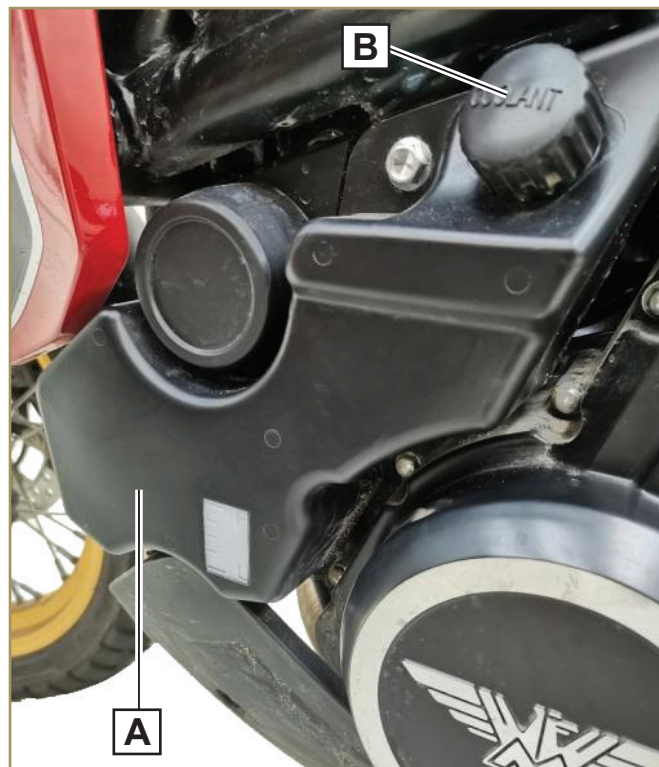



## WARNING!

Unless there is an obvious emergency, don't add water.

## NOTE

If the coolant temperature is too high, the fan is automatically operated and it's protected by a fuse.



## WARNING!

If the coolant consumption is irregular or the cooling system leaks, please do not use the motorcycle and contact a MOTOMORINI authorized service center.



## Brake pads

### Wear check

Inspection: every 5,000km



### IMPORTANT

Used on dusty roads, wet roads, winding roads or mountain roads, the brake pads of motorcycles need more frequent wear inspections.

- It is not necessary to remove the brake pads when performing the inspection.
- There are indicating grooves on the friction material of the front brake pads to determine whether to replace the brake pads;
- When the brake pads are still in good condition, the grooves can be seen.

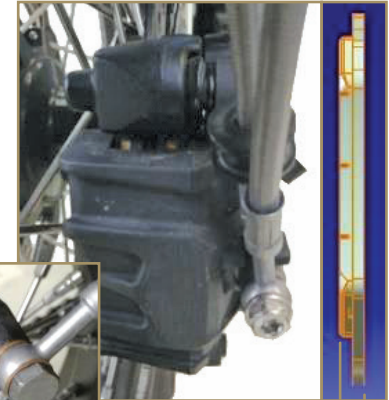

min 4,5mm



### INTERVENTIONS

The minimum thickness of the brake pad friction material is 4.5 mm. If one brake pad is excessively worn, both brake pads must be replaced at the same time, and the original brake pads must be used.

## Transmission Chain

### NOTE

Users need to check the tension and lubrication of the transmission chain frequently.

- Park the motorcycle on level ground:
- Press the chain upward at the middle part of the lower chain:
- Observe the displacement of the chain to judge the tightness; usually the displacement is 25-30mm. If there is a high degree of slack, please adjust the chain tension at the MOTOMORINI authorized service center.

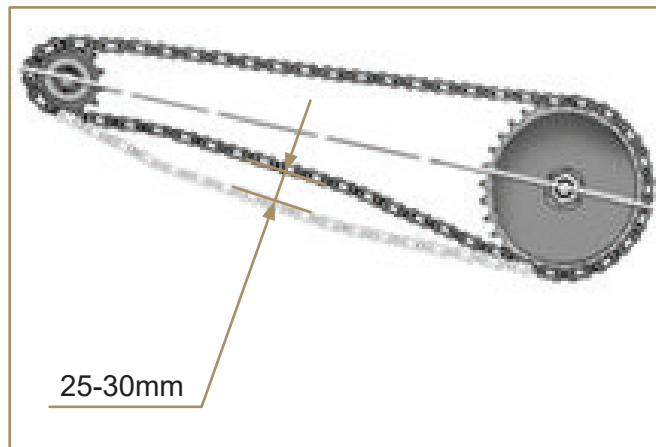

### WARNING!

Improper chain tension may cause premature wear of the front and rear sprockets and chain.

Lubricate every 700 kilometers (or more frequently when driving long distances on dusty or wet roads). Use special products for lubrication, and carefully follow the terms of use on the product packaging. Use the special lubricants for motorcycle chains to lubricate.

## Electrical components

### Fuses

- Remove the passenger seat;
- Open the fuse box cover;
- Before replacing the fuse, try to solve the problem that caused the fuse to "burn out";
- Find and remove the blown fuse, and then replace it with a fuse of the same rating.



### WARNING!

When replacing the fuse, be sure to use a fuse of the same rating, because it may seriously damage the electrical system and cause a fire due to a short circuit.

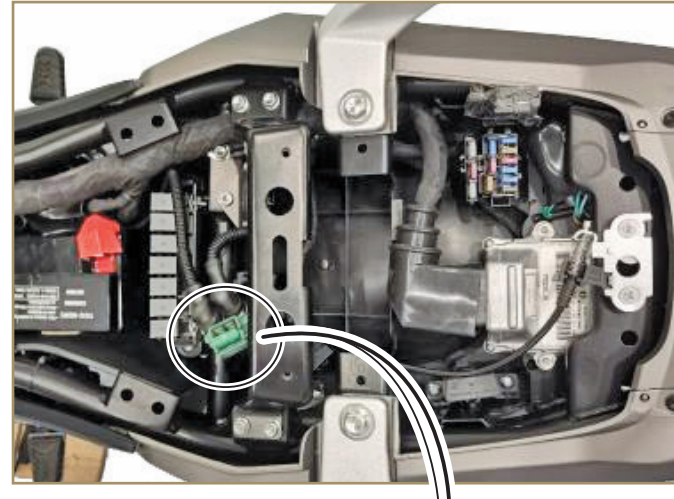

1

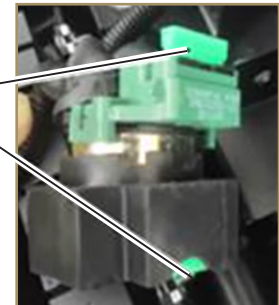

No.	Ah	Functions
1	30	Starter motor & spare fuse



No.	Ah	Functions
2	15	Headlamp and signal system
3	5	ABS system
4	10	Lambda sensor heating
5	15	Fuel pump relay, main relay
6	15	Fan relay/start auxiliary relay
7	7.5	ECU
8	15	Spare fuse
9	10	Spare fuse
10	5	Spare fuse
11	25	Spare fuse
12	10	ABS system
13	25	ABS system

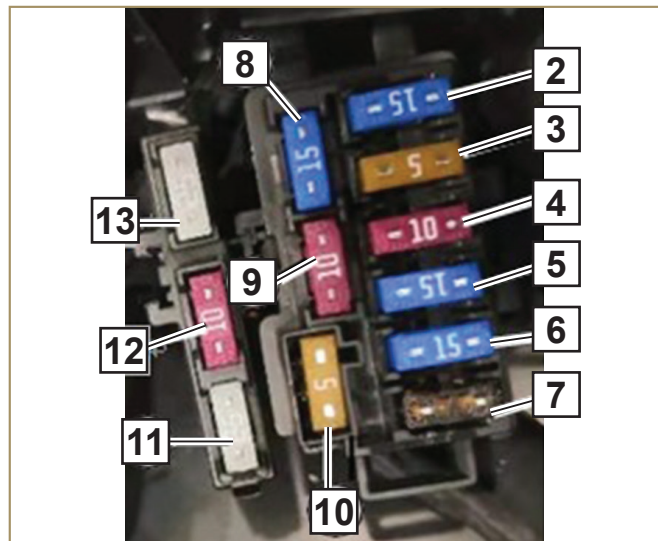



## Battery

The battery installed on the motorcycle is a wet maintenance-free type, so there is no need to check the battery electrolyte level or add distilled water.

### NOTE

Do not remove the sealing strip, otherwise the battery will be damaged. Do not install traditional batteries on the motorcycle, otherwise the electrical system will not work properly.

## Battery Maintenance

It is the owner's responsibility to maintain sufficient power in the motorcycle battery.

Otherwise, it may cause the battery to lose power and cause the motorcycle to break down.

If your motorcycle is not used for a long time, you should use an appropriate charger to charge the battery or remove the vehicle battery.



### WARNING!

Do not charge or place the battery near a heat source or open flame; keep out of the reach of children. The battery can only be charged with a dedicated charger, which can be charged in your motorcycle dealership store.

## Remove the battery

- Make sure the ignition switch is turned off
  - To remove the driver's seat, please refer to the section "Remove the driver's seat" in the section on basic information.
- Disconnect the battery cable, first disconnect the negative (-) terminal, then the positive (+) terminal
- Loosen the screws that secure the cables to the battery terminals.
  - Remove the battery.



### **WARNING!**

Do not open the battery, do not add distilled water or electrolyte.

## Re-Install the battery

- Place the battery on the battery box.
- Connect the positive (+) cable to the positive (+) terminal, and then connect the negative (-) cable to the negative (-) terminal.
- Place the battery vertically at the designated position.
- Cover the positive (+) terminal with red insulation.
- Put the cables on the terminals and fix them with screws.
- Tilt the battery and insert it into the seat.



### **WARNING!**

Connecting the negative wire to the positive terminal of the battery or connecting the positive wire to the negative terminal of the battery will cause serious damage to the electrical system.

**Red = positive (+)**

**Black = negative (-)**



## IMPORTANT

Pay attention to the location of the terminals and the polarity of the cable.

**Red = positive (+)**

**Black = negative (-)**

## Headlamp



## INTERVENTIONS

Regularly check the beam pattern of the headlights at MOTO MORINI authorized service centers or trusted service centers.

- Adjusting the lights up and down by directly rotating the inner screw under the headlight.
- Parking light: 6.5W.
- Low beam/high beam: LED-10.2W/24.6W.

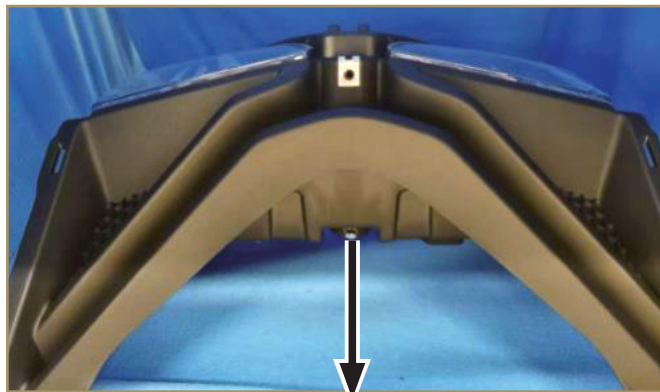

Adjustment devices, following this scheme:

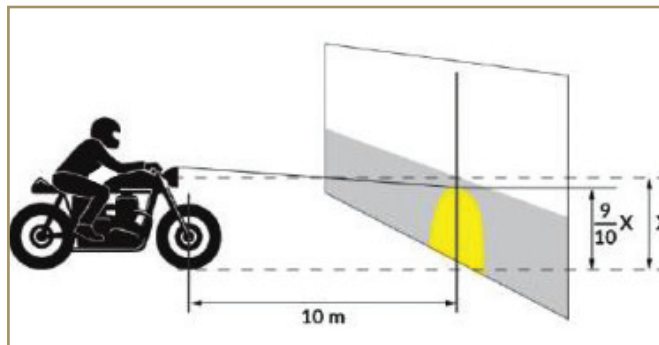

## **Turn signal**

The direction indicator uses a set of non-replaceable LEDs. If the indicator does not work, the entire indicator must be replaced at a MOTOMORINI authorized service center.

## **License plate light**

The license plate light uses a set of non-replaceable LEDs. If the lamp does not work even though the system is complete, the entire lamp body must be replaced at a MOTOMORINI authorized service center.

## **Tail light**

The tail light uses a set of non-replaceable LEDs. If the light does not work despite the complete system, the entire light must be replaced at a MOTOMORINI authorized service center.

**MOTOMORINI®**



ITALIA DAL 1937