

OWNER MANUAL

Rev. 01 | Ed. 01 | 10/2022
Cod. X4644101



SEIEMEZZO

VEHICLE DESIGNED IN ITALY, PRODUCED AND ASSEMBLED IN CHINA

Dear Customer,

- *Congratulations on your excellent choice.*
- *Your new motorcycle is the result of the strictest tests and it represents the most up-to-date display of technology in this field.*
- *A trouble-free operation of the motorcycle through time depends on the use it will be subjected to and on appropriate maintenance. For this reason, we strongly suggest you conform to the information stated in this booklet, which must be carefully read before operating the motorcycle and will have to be consulted any time there is even the smallest doubt. In case you should lend your motorcycle (we strongly discourage doing so) to a friend, make sure they have read the paragraphs concerning riding safety and use of the motorcycle itself.*
- *For servicing, extraordinary maintenance, spare parts and accessories always and exclusively refer to Moto Morini authorized Service Centers.*
- *This manual must be preserved for the whole life of the motorcycle and in case of transfer of title it will have to be handed over to the new owner.*
- *All information reported in this manual is up-to-date as of printing date.*
- *Moto Morini reserves the right to apply all changes required by the evolution and development of its motorcycles without notice obligation.*

Always abide by the traffic laws, ride carefully and... Have a good journey!

Accompanying documentation of the motorcycle ...	2	Left-Head side (STR)	20
Motorcycle identification data	2	Right-hand side (STR)	21
Consultation Notes	5	General Information (SCR)	22
Symbols	5	Main component location (front)	22
Basic rules	6	Left-Head side (SCR)	23
Clothing	10	Right-hand side (SCR)	24
Riding with a passenger	10	Supplied equipment	25
Accessories	11	Provided keys	26
Load (Baggage)	12	Ignition Switch	27
Technical features	13	Fuel Tank Cap	28
Engine	13	Saddle	29
Timing system	13	Saddle removal.....	29
Fuel system	13	Saddle assembly	29
Exhaust system	13	Dashboard	30
Valve clearance	14	Indicator light (Specific function)	31
Lubrication	14	Basic information of vertical menu	34
Cooling system	14	Disconnecting a device	38
Transmission	15	Basic information of horizontal menu	46
Homologation	16	Basic information of display function	47
Overall dimensions	17	Basic information of warning function	52
Electrical System	18	Clutch lever	55
Fluids/Lubricants	18	Distance adjustment	55
General Information (STR)	19	Front Brake lever	56
Main component location (anteriore)	19	Distance adjustment	56
		Check of the clutch cable	57

Front fork	58	Transmission Chain	96
Adjustment of compression	59	Electrical components	97
Rear shock absorber	60	Fuses	97
Rebound adjustment	61	Ignition coils diagnostics sockets	99
Gear shifting lever	62	Battery	100
Start	62	Battery Maintenance	100
Gear shift:	62	Remove the battery	101
Position adjustment	63	Re-Install the battery	102
Rear Brake Pedal (1)	64	Headlamp	103
Side Stand	65	Indicator lights	104
Tires	66	License plate light	104
Fuel Tank	68	Tail light	104
Refueling	68		
Terms of use	69		
Run-in (1000 km)	70		
Check items before use	71		
Riding skills	72		
Safety precautions for the first use of motorcycles	73		
Maintenance	83		
Daily maintenance	88		
Engine oil	89		
Brake fluid	91		
Liquid level check	92		
Coolant	93		
Brake pads	95		

Consultation Notes

Symbols





- Symbols highlighting situations of maximum attention, practical advice or information have been used in order to ensure a quick and practical reading.
- Said symbols can be located next to a text (thus referring to that text only) next to a picture (referring to the subject of the picture and its text) or at the top of the page (referring to all topics treated in the page itself).

NOTE

Pay attention to the meaning of the symbols: their purpose is to avoid repetition of technical concepts or safety warnings.

NOTE

Some pictures could differ from the motorcycle in use.

SYMBOL	DESCRIPTION
	WARNING! Dangerous situations with grievous bodily harm or even death.
	IMPORTANT Possibility of damage to the motorcycle or parts of it.
	NOTE Topic of specific importance.
	INTERVENTIONS Interventions pertaining to the Authorized Service Centre.
	OPERATIONS Operations to carry out with the engine off.

Basic rules

- It is necessary to have all the requirements provided for by law in order to ride the motorcycle: minimum age, psychophysical eligibility, etc. in addition to the country-specific required documentation: driving license, registration, road tax, insurance, number plate etc..
- Good psychophysical conditions are essential for safety while riding the motorcycle. Drugs, alcohol abuse, psychotropic drugs etc., in addition to physical weariness and sleepiness can cause very dangerous situations.
- It is advised to use a helmet, in compliance with the current regulations in the reference country.
- It is advised to use all protective devices, reinforced jacket, boots and gloves.
- It is advised to become familiar with the motorcycle by initially riding it in low-traffic areas.
- A good percentage of motorcycle accidents are caused by the rider's inexperience.
- Never lend the motorcycle to beginners or inexperienced riders.
- Ride in a seated position, both hands firmly placed on the handlebar and feet correctly placed on the footrests. Avoid standing up and stretching out the legs while riding. In case of numbness of the limbs on long-distance routes, do not hesitate to stop in specific rest areas and do some simple exercise to restore blood flow and tone up the muscles. Never ride in a state of physical weariness or drowsiness.
- Rigorously abide by signage and national/local rules.
- Keep a safe distance from other vehicles when riding in a straight line.
- Always ride with the low beam switched on, even in daylight.
- Avoid abrupt and potentially dangerous moves.
- Adjust your riding style according to road surface.

- Adjust your riding style according to the additional load carried on the motorcycle, especially in presence of a passenger.
- It is forbidden to challenge other vehicles' drivers on public roads.
- Avoid riding the motorcycle off-road as much as possible.
- When the road is wet or slippery, ride with maximum concentration. Use the brakes gently and mainly use the engine brake.
- Always ride so to be very visible in every condition. Do not ride in the “blind spots” of the vehicles in front of you.
- Pay extreme attention at crossroads that have no traffic lights, when close to an access to private areas or public parking areas, in entry lanes to ring roads or motorways.
- When refueling the motorcycle, always switch the engine off. Do not smoke when performing the aforementioned operation.
- Remove the ignition key during stops (even short ones) if the motorcycle is left unattended.
- Park the motorcycle so that it cannot be bumped into, especially by pedestrians as the engine, the exhaust pipes and the silencer maintain a high temperature for a long time.
- Never park on rough or soft terrains or asphalt that has been softened by sunlight.
- Changes of direction or lane, side street turns, pull overs for parking or stopping must always be signaled well in advance by using the direction indicators.
- Whenever close to crossroads, stops, traffic lights, level crossings, holes, ditches, speed bumps and any other perceivable obstacle, slow down in time with moderation.
- When the engine is switched off and the ignition key is positioned to “ON”, the low beam switches off

after a few seconds.

- Before every trip, always check: tire wear and pressure, efficiency of the lighting and braking systems, engine oil and coolant levels.
- Only use the products recommended by Moto Morini. In case of any top-ups, avoid mixing different, incompatible oils with one another.
- Do not ride with the helmet hanging off your arm or off the handlebar, even for short commutes. The helmet must be worn during every motorcycle ride (this applies to the passenger as well).
- Never distract oneself or get distracted while riding.
- Do not use mobile or audio devices while riding.
- Do not use earphones, only use appropriately homologated devices for these purposes.
- Alterations and tampering (even minor ones) exempt the manufacturer from any responsibility regarding any kind of damage and cause the termination of the warranty rights

**WARNING!**

Do not ride in the stream of the vehicles ahead.

Do not ride paired up to other riders.

Do not tow or get towed by other vehicles.

Do not sit on the motorcycle while it is parked on the kickstand.

Do not put the motorcycle on the kickstand when the travel direction goes downhill.

Do not start the engine in indoor spaces.

Do not ride on pedestrians' walks, under covered walks, on public park lawns, etc.

Do not keep pointy or fragile objects in your pockets while riding.

Do not ride in case of adverse weather conditions (temperatures close to 0° C, ice, snow, heavy rain, etc.).

Clothing

- Appropriate clothing consists of protective garments in light or refractive colors in order to always be perfectly visible even in poor visibility conditions. Avoid any loose-hanging tails, unbuttoned jackets, excessively heavy or tight gloves and inappropriate shoes.

Riding with a passenger

- Carrying a passenger on the seat influences the riding to a great extent. The weight has a direct effect on the tires, whose pressure will need to be increased and on the rear shock absorber, that will have to be calibrated properly. The braking distance is considerably longer and bends have to be taken at a wider range, with a reduced lean angle and measured throttle opening. A higher degree of caution is also mandatory.
- Both rider and passenger must necessarily wear homologated, properly tied up helmets. The helmet must be properly sized, intact and with a perfectly clean visor.
- Briefly instruct the passenger on the behavior they will have to adopt before every trip (even short ones): do not make any abrupt move during the ride, do not place the feet on the ground during short rests such as stop signs or traffic light stops, do not look over the sides during the ride to look ahead, do not turn the head backwards and, above all, do not counterbalance the curve preparation set by the rider.
- Clear display of passenger anxiety must necessarily lead to highly cautious and careful driving.

**WARNING!**

Do not carry elderly or disabled people, children or animals.

Do not carry children on the motorcycle tank.

Accessories

- Moto Morini shall not be liable for any kind of damage resulting from the use of unexpected, non-homologated or in any way incompatible accessories according to the structural features of the motorcycle or accessories that have not been installed following the technical specifications of said accessory's manufacturer or Moto Morini or accessories that are not officially approved by Moto Morini's technical department (example: windscreen, luggage rack, top case, side panniers or bags, fairings, additional lights, etc.).
- The motorcycle user is responsible for the choice, set-up and practical use of the accessories. During set-up, it is important to verify that the visual and acoustic indication devices are not covered, the suspension travel and steering angle are not limited, the use of control devices is not hindered and ground clearance and leaning angle are not reduced.
- Always check that the accessories are properly attached to the motorcycle, especially in view of long journeys.
- Any accessory that modifies side and/or frontal clearances can cause vehicle imbalance, even if it is an original Moto Morini accessory. In these cases, it is advised not to exceed a 130 Km/h speed even if allowed.

NOTE

Always use original Moto Morini Accessories set up by the authorized Service Centre.

Load (Baggage)

- Baggage must be loaded so that its total weight is equally distributed on both sides of the vehicle, as close to its barycenter as possible. Baggage must be securely attached to the vehicle and it is good practice to check its correct anchoring during stops. A poorly anchored bag can make the motorcycle unsteady and cause extremely dangerous situations.



WARNING!

Do not position bulky baggage at the sides of the motorcycle; it could hit obstacles or people, causing a loss of control of the motorcycle itself.

Do not fasten any type of object to the handlebar.

Do not fasten any type of object to the front mudguard or close to the fork. This causes poor handling and hinders the regular air flow to the radiator, thus increasing the dangerous risk of the engine overheating.

Do not carry baggage or various types of objects sticking excessively out of the luggage rack or covering the lighting and signaling devices.

Do not exceed the maximum weight limit of the luggage rack. Overload is always a dangerous element while riding a motorcycle.

Do not exceed the load on the tank, especially height-wise.

Technical features

Engine

Twin-cylinder	4-stroke, DOHC
Total displacement	649 cm ³
Bore by stroke	83 x 60 mm
Compression ratio	11.3:1
Power (E5)	41.5 kW - 8,250 rpm.
Engine torque (E5)	54 Nm at 7000 rpm
Power A2 vehicles (E5)	32,5 kW - 9,000 rpm
Engine torque A2 vehicles (E5)	50,5 Nm at 5750 rpm

Timing system

Double camshaft (Hydraulic tensioner)

Fuel system

Electronic fuel injection



BOSCH

Ø38mm throttle body.

Exhaust system

Silencer, 3-way catalytic converter and 2 LAMBDA sensors.

Valve clearance

Intake.....	0.08-0.13mm
Exhaust.....	0.2-0.26 mm

Lubrication

Oil:	Power Synt 10W40
Capacity*: draining	2.6L;
with filter replacement.....	2.2L;
without filter replacement.....	2L

Cooling system

Liquid.

Thermostat starts opening:.....	87-97°C
---------------------------------	---------

Transmission

- 6-Speed gearbox.
- Final drive 15/46
- Gear ratio: Beginning - (2.095), **1st-2.353, 2nd-1.714, 3rd-1.333, 4th-1.111, 5th-0.966, 6th-0.852.**
- Primary drive: spur gears.
- Final drive: chain.
- Clutch: multi-disks wet type.

Homologation

Euro 5 vehicle

- Frame: steel tube structure
Swing-arm: Aluminum die-casting
Wheelbase: 1445 mm - Rake angle: 25° Track: 122mm- Steering angle: 34°
- Front suspension: adjustable inverted fork Ø43mm.–Stroke: 120mm
- Front wheel (standard): A356 aluminum wheel — 3,50x18" – tire: 120/70-R18" (STR)
- Front wheel (upon request): STS 36T spoked wheel — 3.50x18" — Tire: 120/70-ZR18" (SCR)
- Rear suspension: adjustable monoshock: stroke 38 mm
- Rear wheel (standard configuration): A356 aluminum wheel — 4.25x17" – tire: 160/60-R17" (STR)
- Rear wheel (upon request): STS 36T spoked wheel — 4.25x17" — Tire: 160/60-R17" (SCR)
- Brake Front:  **brembo**
Double disc Ø298mm. Caliper with 2 pistons and 2 brake pads per side. Rear: Single disc Ø255mm.
Caliper with 2 pistons and 2 brake pads.
- Fuel tank capacity: 16 l.
- Dry weight: 215 kg

SEIEMMEZZO STR-SCR

Overall dimensions

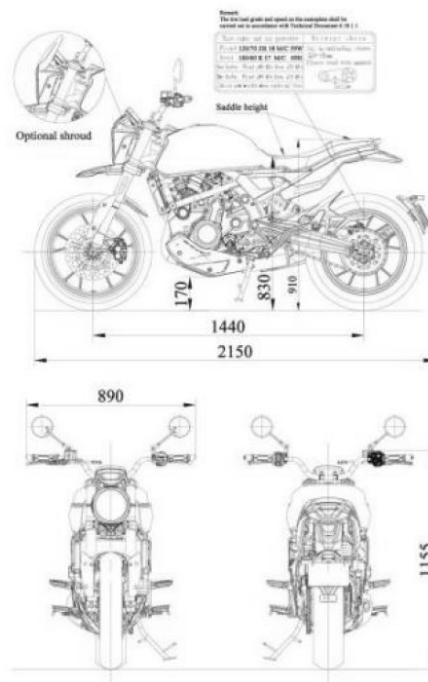
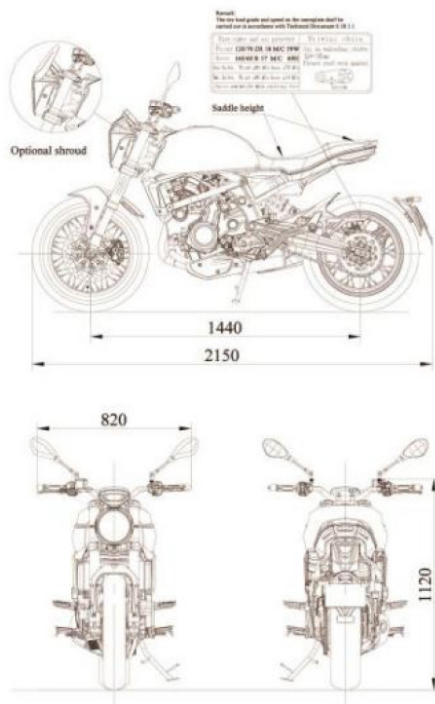

Electrical System

- Battery: 12V - 11Ah
- Instrumentation: Multi-function LCD -TFT Display.
- Spark plugs: CR8EI

Fluids/Lubricants

- Fuel: leaded petrol R.O.N. 95#
- Coolant: COOLANT G40
- Engine oil: 10W40-SN 
- Brake and clutch fluid: BRAKE FLUID DOT 4 

General Information (STR) Main component location (anteriore)

No.	Instruction
1	Rearview mirror
2	Left handgrip
3	Clutch lever
4	Left handle switch
5	Handlebar fixing
6	Right handle switch
7	Handgrip Gas
8	Front brake lever
9	Front brake fluid tank
10	Ignition switch/steering lock
11	Dashboard



Left-Head side (STR)

No.	Instruction
1	Left front brake caliper
2	Auxiliary water tank engine coolant
3	Exhaust pipe
4	Shift lever
5	Side stand
6	Left footplate
7	Drive chain
8	Saddle
9	Radiator-engine coolant
10	Left passenger footplate
11	Rear light / license plate light
12	Rear shock absorber



Right-hand side (STR)

No.	Instruction
1	Rear brake caliper
2	Right footplate
3	Rear brake lever
4	Catalytic converter
5	Right front brake caliper
6	Front light
7	Fuel tank cap
8	Rear brake fluid reservoir
9	Silencer
10	Front shock absorber
11	Right passenger footplate



General Information (SCR)

Main component location (front)

No.	Instruction
1	Earview mirror
2	Left handgrip
3	Clutch lever
4	Left handle switch
5	Handlebars fixing
6	Right handle switch
7	Handgrip Gas
8	Front brake lever
9	Front brake fluid tank
10	Ignition switch/steering lock
11	Dashboard

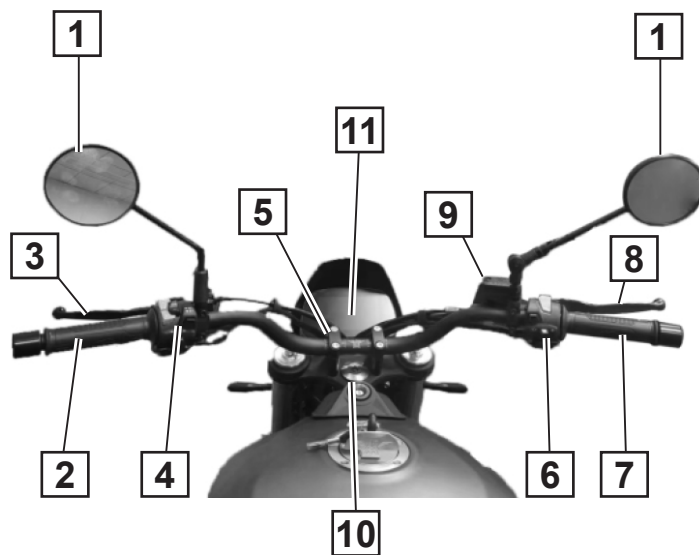

SEIEMMEZZO STR-SCR

Left-Head side (SCR)

No.	Instruction
1	Left front brake caliper
2	Auxiliary water tank engine coolant
3	Exhaust pipe
4	Shift lever
5	Side stand
6	Left footplate
7	Drive chain
8	Saddle
9	Radiator-engine coolant
10	Left passenger footplate
11	Rear light / license plate light
12	Rear shock absorber

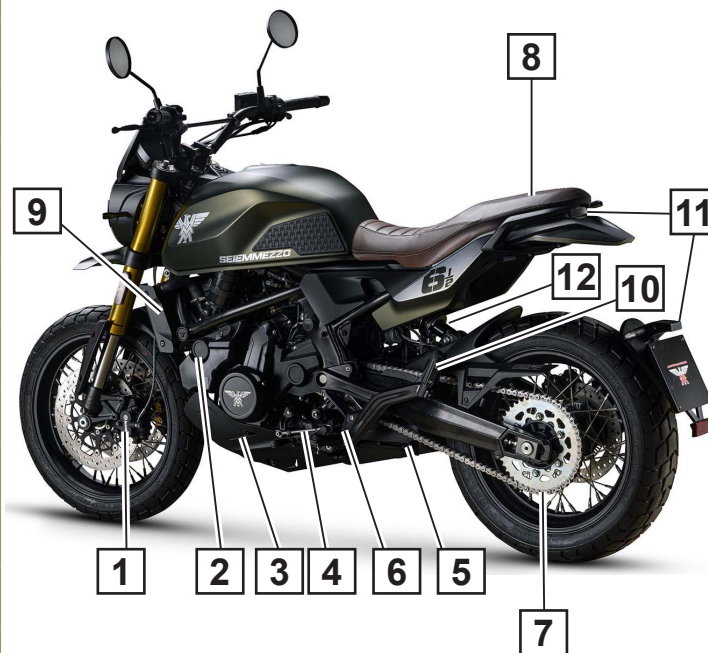

Right-hand side (SCR)

No.	Instruction
1	Rear brake caliper
2	Right footplate
3	Rear brake lever
4	Catalytic converter
5	Right front brake caliper
6	Front light
7	Fuel tank cap
8	Rear brake fluid reservoir
9	Silencer
10	Rear shock absorber
11	Right passenger footplate

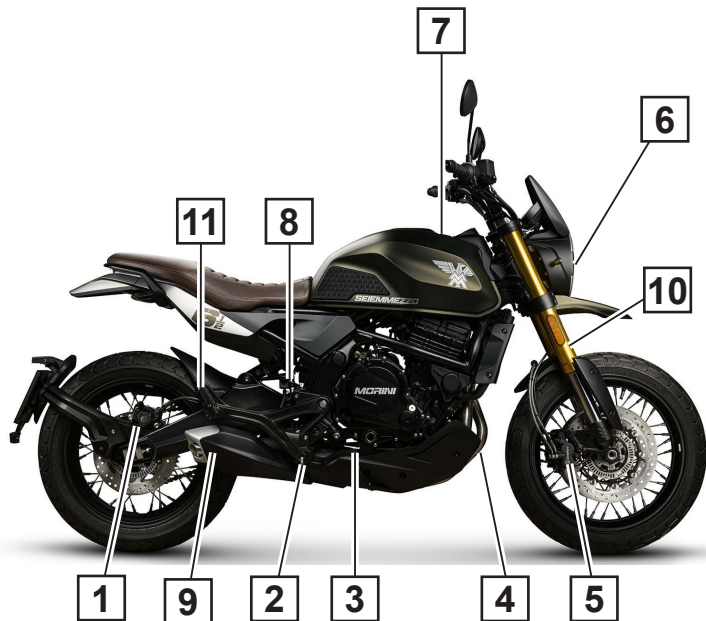

SEIEMMEZZO STR-SCR

Supplied equipment

The vehicle comes with on-board tools:

- Allen wrench (1): Allen wrench.
- Replaceable screwdriver (1): flat head- cross head.
- Wrench (2): size 8-10; size 14-17.

The vehicle tool is located under the passenger seat

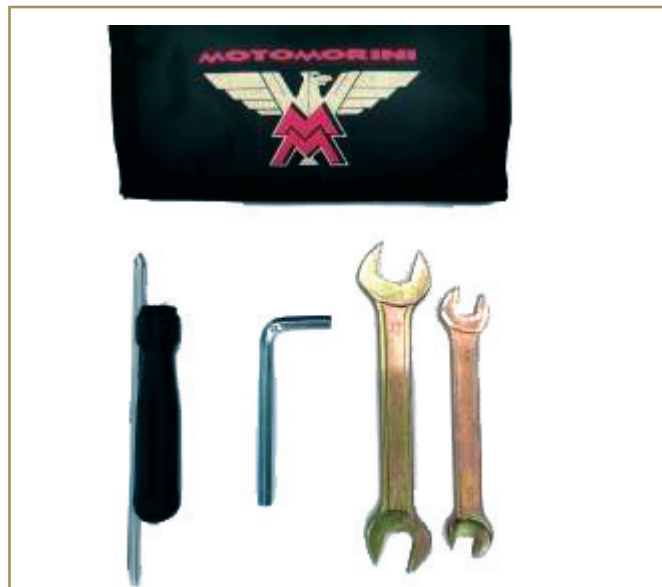

Provided keys

- The motorcycle is delivered with 2 pcs of identical keys.

NOTE

- Separate the two keys and store one of them in a safe place.
- It is recommended to save the key picture for copy after loss(the picture is real key).



IMPORTANT

It is advised to use a keyring made out of soft material that will not mark the exterior of the motorcycle.

NOTE

- In case of a key loss, report it as lost and, if necessary, head to the Service Centre for locks replacement.

Ignition Switch



- The three-position switch is located between the handlebars and the fuel tank.
- The positions can be activated through the key.

Location instruction:

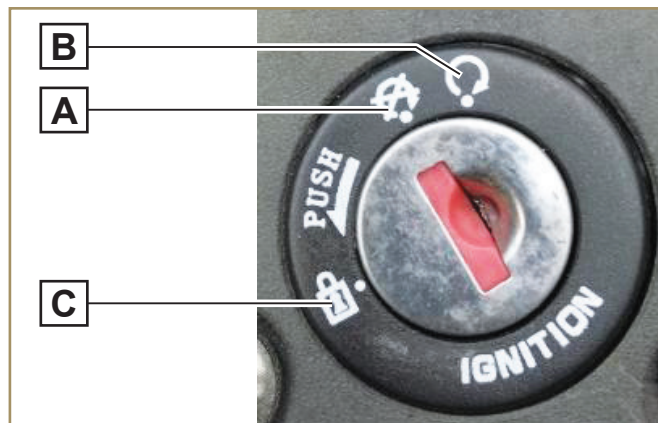
- A. No power, the circuit is disconnected;
- B. Ignition powered: all the electric equipment is operational;
- C. Steering lock.



NOTE

To avoid discharging the battery, start the engine as soon as possible after turning the ignition key to “” position; if it is left in “” position for a long period of time, the battery may discharge:



IMPORTANT

The key can be extracted only when it is rotated to switching off  or engagement of the steering lock position.

Once inserted, the ignition key can be rotated and moved between the various modes. To activate the steering lock, the key must be pressed while it is rotated anticlockwise in the corresponding position;

Fuel Tank Cap

Opening

Before opening the fuel tank cap, pull up the key-hole cover; insert the ignition key(A) into the fuel tank cover, push it into place, turn the key clockwise, and then tilt the cap(B) back;

Close

To close the fuel tank cap(B), turn the key(A) clockwise and push the fuel tank cap until it makes a "click" sound. To remove the key, turn it counter-clockwise to the initial position, remove it, and then close the keyhole cover.

NOTE

After each refueling, check the cap is properly closed.

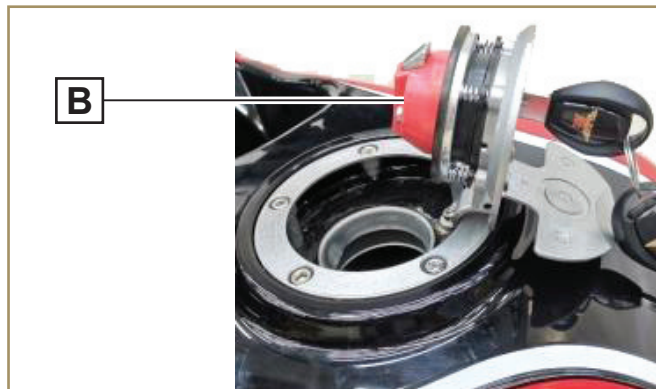

Saddle

Saddle removal

Insert the ignition key into the lock (1) and turn it anticlockwise.

Raise the saddle (2) while keeping the key rotated.

Saddle assembly.

Insert the hook (A) in the front part of the passenger saddle underneath the bracket (B) of the frame, then insert the pin (C) into the lock (D) by pushing towards the rear part of the saddle until complete hooking.

- A. Hook;
- B. Bracket;
- C. Pin;
- D. Lock

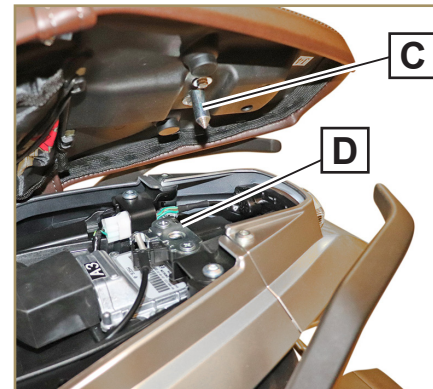
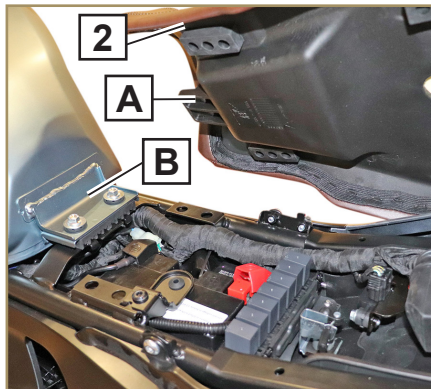
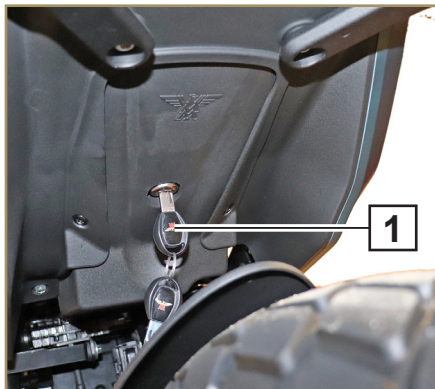

Dashboard



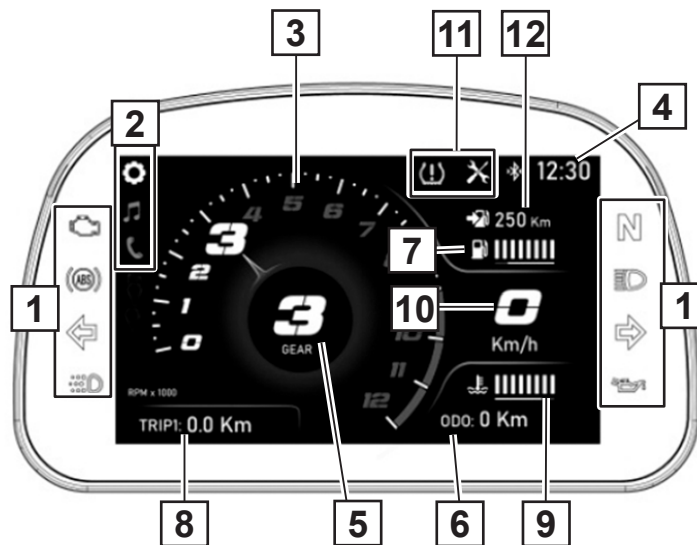

No.	Instruction
1	Signalling lamps
2	Vertical menu
3	Tachometer
4	Time
5	Gear indication
6	Total mileage
7	Fuel gauge
8	Partial mileage
9	Coolant temperature
10	Speedometer
11	Check lights
12	Remaining distance









NOTE

By rotating the key into the ignition block to “” position, all the indicators follow perform a self-test before start-up of the engine.

Indicator light (Specific function)

Warning light	Description	State	Instruction
	Engine warning indicator (yellow)	Turn on	Turn on the ignition switch , the icon should be lit up,
		Flashing	Indicates that the DFI system is malfunctioning. Ask an authorized Moto Morini dealer to check
	ABS indicator light (yellow)	Off	Activate the ignition switch: after the self-test, the indicator light will switch off when driving speed reaches or exceeds 5 km/h (3.1 mph). The ABS indicator light is off, indicating that the ABS system is normal.
		Turned on or Flashing	The ABS is malfunctioning. Except for the traditional brake function, ABS does not work. Ask an authorized Moto Morini dealer to check the ABS.
	Left turn signal indicator (green)	/	When the turn signal switch is pushed to the left, the left indicator light flashes.
	Daytime light indicator (green)	/	When the daytime running light is on, the signaling indicator is on.

Warning light	Description	State	Instruction
	Fuel level warning indicator (yellow) 	Turn on	When there is about 4.0 L of available fuel remaining, a red reminder appears on the lowest grid of the fuel gauge and the fuel level warning indicator starts to light up. Please pay attention to refuel as soon as possible. When the vehicle is leaned on the side stand, the fuel level indicator is not able to display accurately the quantity of fuel inside the tank. Stand the vehicle upright to check the fuel level.
		Turn on	The fuel gauge has no display segment, the remaining fuel available is about 2.0L, please refuel as soon as possible.
	Neutral indicator (green)	/	When the transmission is in neutral, the indicator light is on.
	High beam indicator (blue)	/	When the front light is in the high beam, the indicator light is on.
	Right turn signal indicator (green)	/	When the turn signal switch is pushed to the right, the indicator light flashes.
	Oil pressure warning indicator (red)	Turn on	With dashboard on and engine off, the indicator is lighted up. The indicator is off when the engine is started. If the indicator remains on when the engine speed is at a value equal or higher than idling speed, immediately stop the engine and check engine oil. If the amount of oil is insufficient, add oil. If the amount of oil is sufficient, please check the engine with an authorized Moto Morini dealer.

NOTE



The ABS indicator (yellow) remains on in the following cases:

1. At the start-up of the engine with side stand raised, the rear wheel rotating and the front wheel still:
2. When the motorcycle is exposed to strong electrical interferences:
3. If this happens, please turn off the ignition-switch first, then turn it on again, and drive the motorcycle at a speed of 5km/h (3.1mph) or higher.

The ABS indicator light should go out. If not, please go to an authorized Moto Morini dealer to check the ABS.

Basic information of vertical menu

The vertical menu has:

1. Setting function
2. Music function
3. Call function

The lit icons can be used to set the corresponding functions, the relevant operation buttons are located on the left-hand switch combination.

On the left switch there are four keys, which allow to perform the following three actions:

4. Select the desired option;
 5. Confirm;
 6. back.
- The selector (4) (▼ or ▲): you can scroll up and down to select various options;
 - SET button (5): confirm the selected option and open the corresponding application;
 - BACK button (6): Exit the option and close the corresponding application;

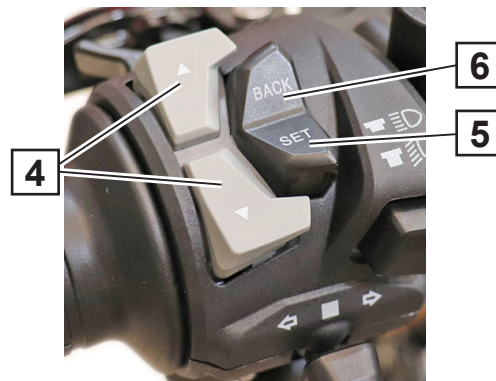

SEIEMMEZZO STR-SCR

1. Setting menu:

contains vehicle information, device connection, screen display, and system information.



Press the SET key

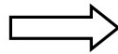

Select the information on the vehicle and press the SET key to consult them

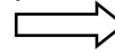

Vehicle Information:

- Maintenance:** The first mileage for a maintenance intervention is 1000Km; the second maintenance will be carried out at 6000km afterwards. After the oil is changed, the remaining mileage for next maintenance is displayed. When the remaining mileage is 100Km, a maintenance prompt symbol will appear on the main driving interface, prompting the user to perform maintenance as soon as possible;
- Trip 2:** This tool allows to save the partial kilometres from the last zeroing.

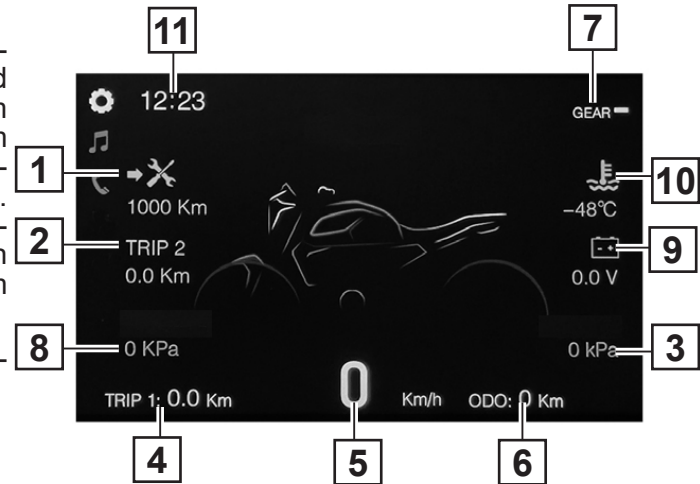

3. **Rear tire pressure:** displays the current value of the rear tire pressure of the vehicle.
4. **Trip 1:** This tool allows to save the partial kilometres from the last zeroing.
5. **Speed:** Displays the current speed value.
6. **Total mileage:** displays the total mileage of the vehicle.
7. **Gear engaged indicator**
8. **Front tire pressure:** displays the value of the current front tire pressure of the vehicle
9. **Voltage:** displays the current battery voltage.
10. **Coolant temperature:** displays the current coolant temperature of the vehicle.
11. **Time.**

NOTE

When the tire pressure is abnormal, please check and repair it with an authorized motorcycle dealer.

2. Device connection



Press ▼ or ▲ to select devices' connection



Press the SET button



Select Earphone 1, press SET button

Description:

- (a) The device connection function can only be used after the Bluetooth connection between the mobile phone and the dashboard is complete;
- (b) Earphone 1 is the main device, with telephone answering function;
- (c) Earphone 2 is an auxiliary device, which can be selected only when the Earphone 1 device is selected. The operation mode is the same as the selection mode of the Earphone 1, without the call function.

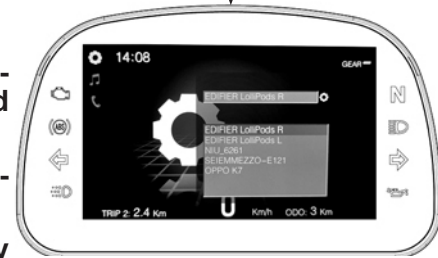

Press ▼ or ▲ to select Bluetooth device, press SET button

Disconnecting a device

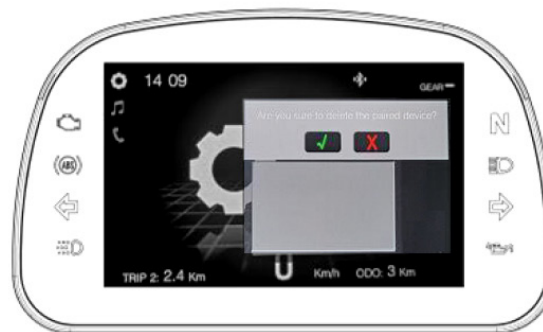
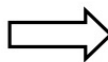
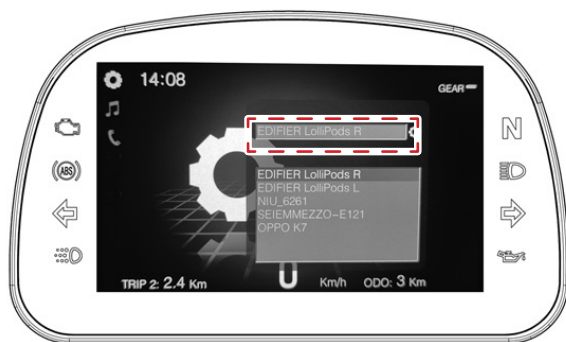

Press ▼ or ▲ to select the connected blue-tooth device



- ✓: Press the **SET** button to disconnect the device
- ✗: If it is not desired to disconnect the device, press **BACK**

3. Visualization of the screen: includes the choice of visualization and brightness

Choice of visualization:

The user can choose the type of visualization of the display in function of its driving habits.

1. **Automatic mode:** In this mode, the vehicle can switch between day mode and night mode according to the actual driving conditions.
2. **Day mode:** It is suitable for daytime driving and ensures the best visual visibility.
3. **Night mode:** suitable for driving at night to ensure the best visual visibility.

With "✓" for the currently selected state, press ▼ or ▲ to the corresponding mode, press the **SET** key to confirm the selected state, and press **BACK** to return.

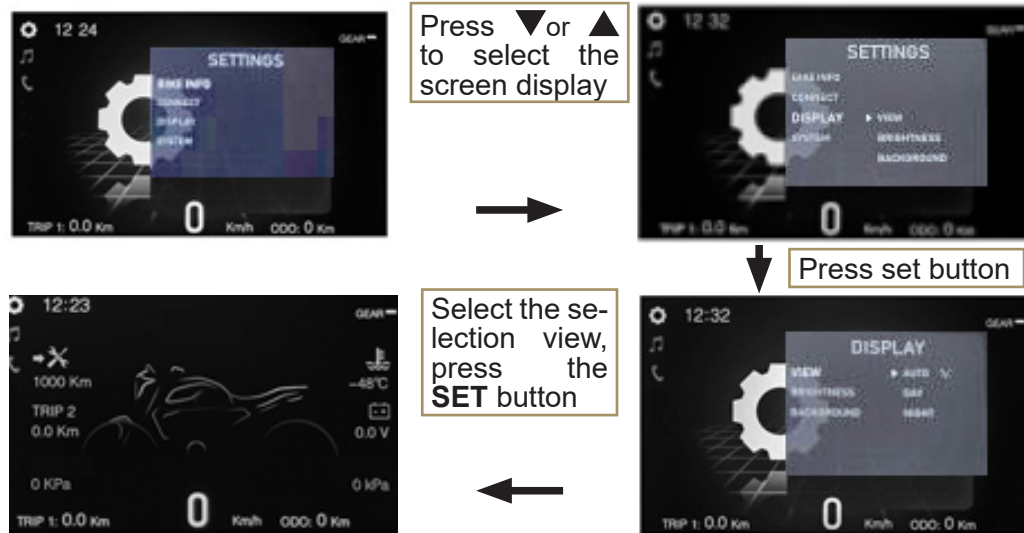

Brightness adjustment: equipped with automatic mode and manual mode.

- 1. Automatic mode:** automatically adjust the screen brightness according to the brightness of the surrounding environment of the vehicle
- 2. Manual mode:** the user can adjust brightness in function of his driving habits. Each time ▼ or ▲ are pressed, brightness is adjusted by 5%.



With "✓" for the currently selected state, press ▼ or ▲ to the corresponding mode, press the SET key to confirm the selected state, and press BACK to return. When the manual mode is selected, press the SET button a few seconds, an adjustment bar "75% - [] +" appears, press "▲(+)" or "▼(-)" to adjust the brightness.



4. System information: There are settings for language, unit, and time functions.

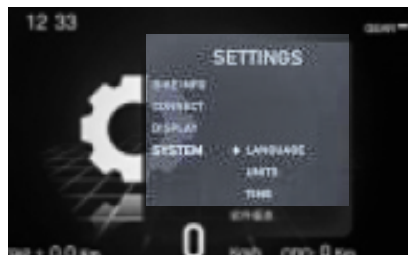
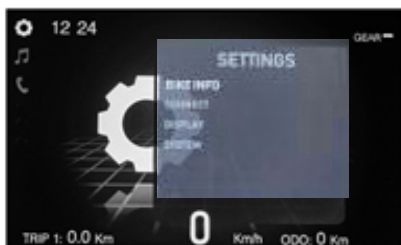

Press ▼ or ▲ to select system information



Press the **SET** button

Language: There are three languages: Chinese, English and Italian, and users can choose the language they need according to their needs.



Press the **SET** button after selecting the language



With "✓" for the currently selected state, press "▲" or "▼" to the corresponding language, press the **SET** key to confirm the selected state, and press **BACK** to return.

Unit: There are two units : Metric Unit and British Unit. After selection, the main interface will display related values according to the selected unit.



Press ▼ or ▲ to select the unit of measurement

Press ▼ or ▲ to select the language

Press the SET key to confirm your choice

Time: allows to set the time



Press ▼ or ▲ to select the time

Press ▼ or ▲ to select the time

Press the SET key to confirm your choice

Software version:

it is possible to display the information on the software version and its respective release.



Press ▼ or ▲ to display the system information



Press ▼ or ▲ to select the software version



Press the SET key to confirm your choice

Music function menu: When  appears, you can play music through the mobile phone by connecting via Bluetooth (name: SEIEMMEZZO-XXXX). Press the **"SET"** button in the music menu to play and pause, press **"▼"** or **"▲"** to go to the previous track or next track. Volume adjustment function: the volume will be memorized after the volume adjustment, and will stay in its position during the next adjustment.



Select  Press the SET button

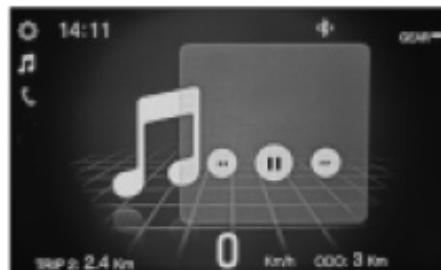

Long press **"▼"** or **"▲"** key

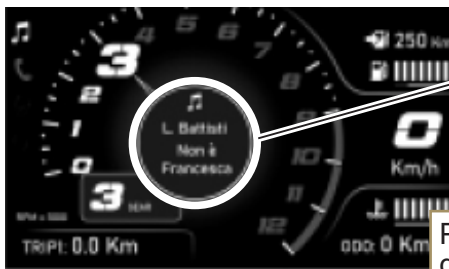

Floating window of music being played



Press **"▼"** or **"▲"** to increase or decrease the volume

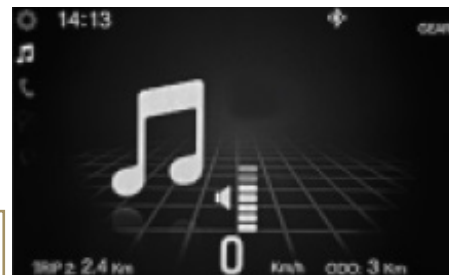

SEIEMMEZZO STR-SCR

Call function menu: when  appears, you can make a call or answer. When a call is received, the calls page appears is displayed, press SET to answer, BACK to hang up; after an answer; the fluctuating frame of the call appears on the main interface.

Proceed as follows in order to make a call:

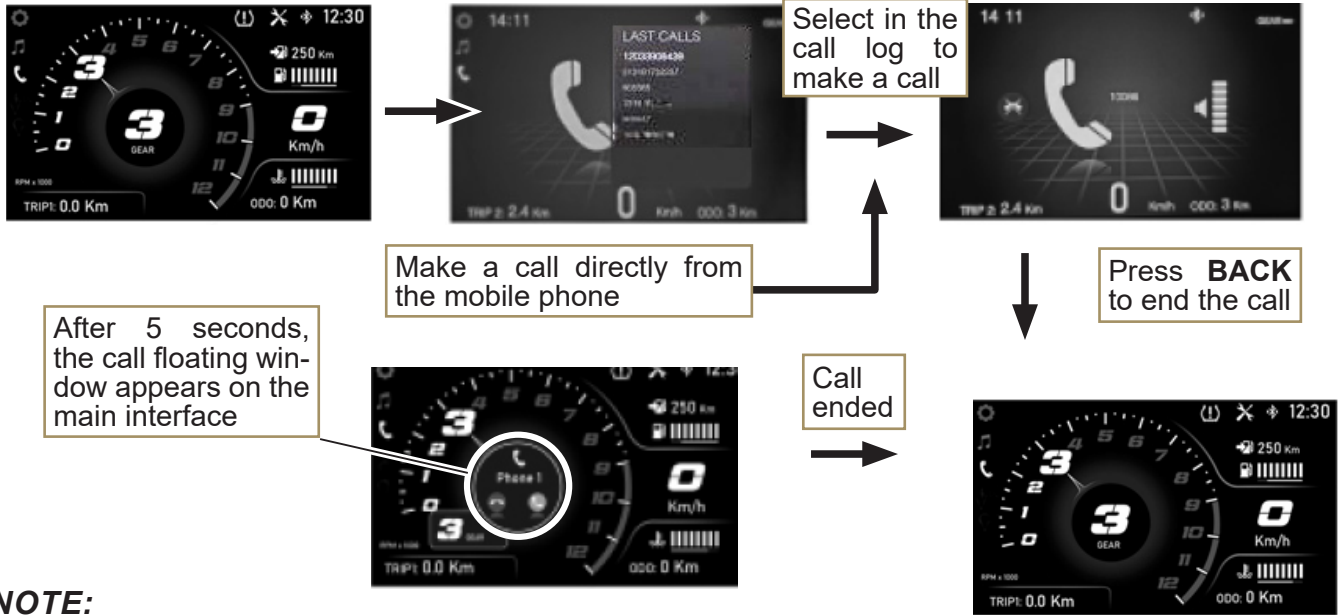

NOTE:

Press "▼" or "▲" key to increase or decrease the volume

Basic information of horizontal menu

The horizontal menu is equipped with: single mileage setting main interface mode.

Single mileage: There are two counts of TRIP1 and TRIP2. After activation according to the following operations, the single mileage can be reset and option settings can be set according to the user's needs.

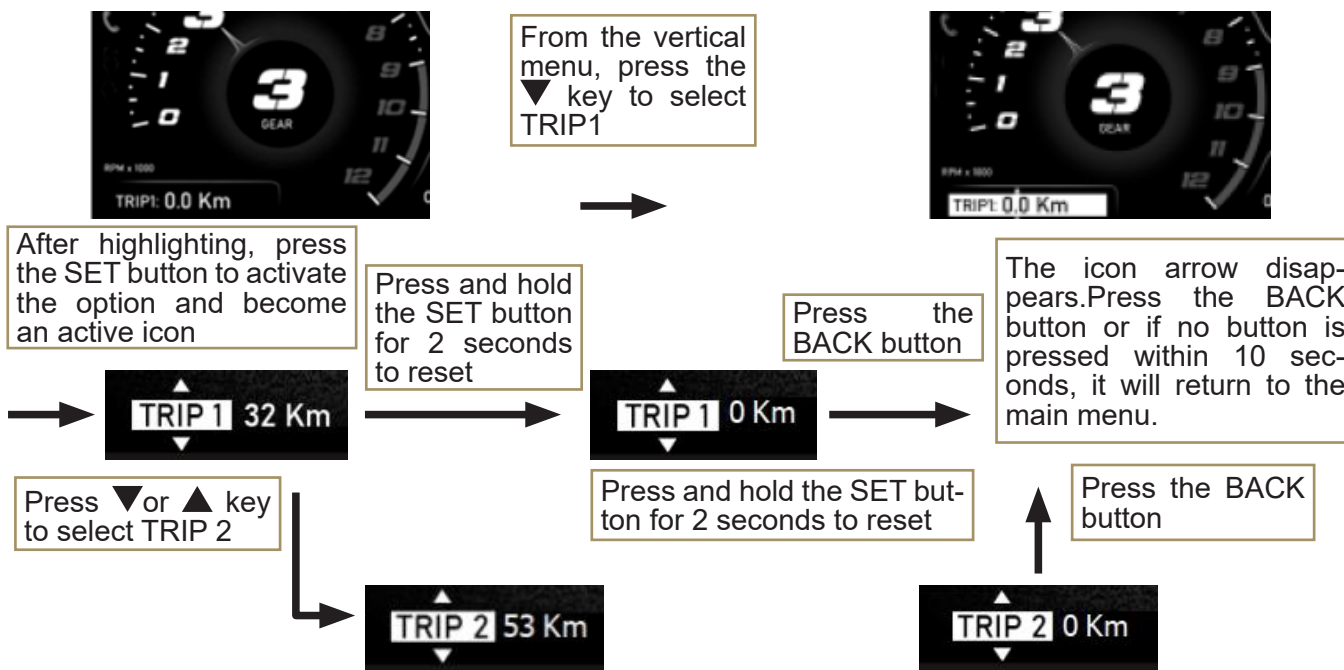

Basic information of display function

Time: the visualization of time changes according to the setting, 24 hours or 12 hours. For the method of adjustment, consult the "Time" paragraph.

Indication of engaged gear: Shows the engaged gear in real time, on the display appears the engaged gear from "1 to 6" or "-" which indicates that neutral gear is engaged, in this case, the neutral indicator "N" lights up on the display.

Total mileage: ODO displays the total distance travelled by the vehicle. The display range is 0-999999Km (620999Mi). When the total mileage reaches 999999Km, it will be reset to 0 Km.

Speedometer: The speedometer is digitally displayed and can be set according to km/h or mph. The unit settings should be changed according to local regulations.

Please be sure to set the unit (km/h or mph) correctly before driving.

To set the unit of measurement "Km or mi", consult the paragraph "Unit of measurement"



Rev counter: the rev counter displays the revolutions per minute of the engine (revolutions per minute, RPM). The rev counter lights up in function of the reached revolutions: the displayed value increases with the number of revolutions. When the speed is greater than 9000RPM, the display is in the red zone.

NOTE

Avoid reaching the red area of the over-speed. Running in the red zone will overload the engine and may cause serious damage to the engine.

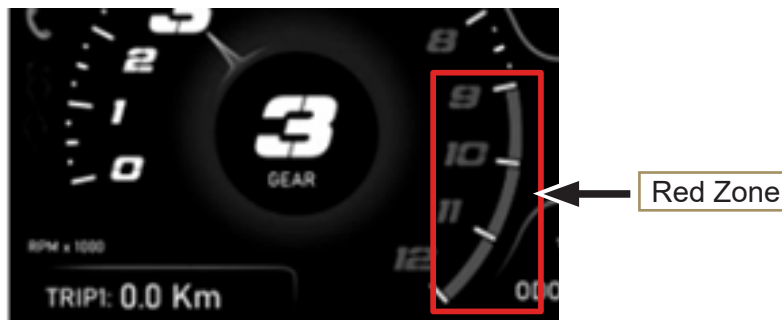

Fuel gauge: The fuel quantity is displayed in eight segments. When the last segment is reached, the notch turns red, the symbol "⛽" lights up in yellow. When the fuel gauge has no display segment, the remaining fuel available is about 2.0L. Please refuel as soon as possible.

When the fuel sensor is faulty, the fuel gauge is displayed in red for the first and eighth segments.

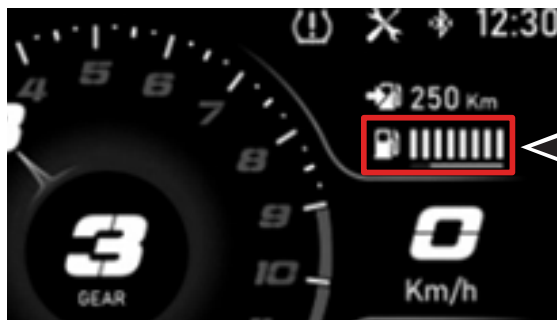

Fuel warning light

Remaining distance: shows the remaining distance which can be travelled with the fuel remaining inside the tank.

This distance is indicative as it changes in function of the route and driving style.

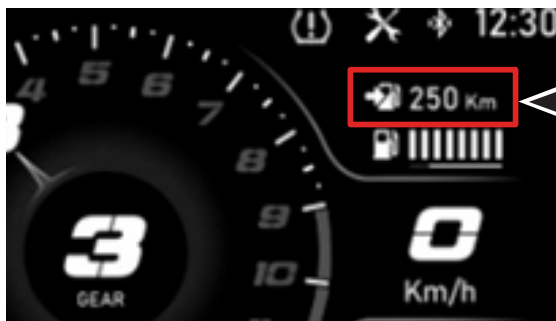

Remaining distance

Coolant temperature indication: display the temperature status of the engine coolant. When the temperature reaches the corresponding value, the display segment will be displayed (see the figure below), When the coolant temperature rises to between 110°C (230°F) and 118°C (244°F), a red warning appears in the display to warn the driver that the coolant temperature is too high. When the temperature reaches 118°C (244°F) and above, the second red warning will appear on the display segment and the 118°C temperature display will appear on the screen. At this time, the engine needs to be turned off. After the engine has cooled down, check the coolant level in the storage tank and check whether the cooling system is faulty. For detailed information about the coolant, please refer to the vehicle information in the setup menu.

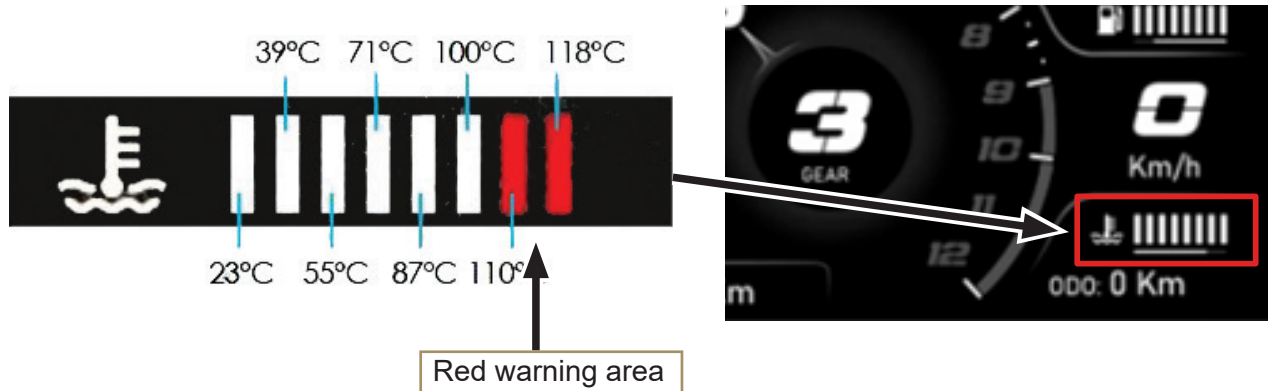

Basic information of warning function

Bluetooth:

After the mobile phone is connected to the Bluetooth of the instrument,  will display on the main interface of the instrument, indicating that the connection is normal, and the music and call functions can be performed by pressing the button.

Maintenance warning:

When the distance to the next maintenance is 100Km, a prompt  will appear on the instrument interface, and the user needs to maintain the vehicle as soon as possible. The first maintenance mileage is 1000Km, and each subsequent maintenance distance is 6000Km. For details of maintenance, please refer to the vehicle information under the setting menu.

Maintenance reset:

After the user has completed the maintenance of the vehicle, he can press and hold the "▼" and "▲" at the same time until the  symbol disappears, the maintenance mileage in the vehicle information is reset to 6000Km, and the next maintenance mileage calculation starts.

Tire pressure warning:

When the tire pressure value is not bigger than 180KPa or not less than 320KPa, a yellow "" will appear. When the symbol is prompted, the user should check and repair the tire according to the specific situation.

1. "Overtaking(passing) lights" button-

The headlight high beam sends a signal to the driver ahead to warn that the vehicle is about to pass; Release the button and the signal light will be turned off;

2. Horn button-

Press the button and the horn starts to work;

3. Turn signal button-

When the turn signal light switch is set to the left (←) or right (→), the relevant signal lights start to flash continuously. When it stops flashing, push the switch;

4. Light switch button-

High beam/low beam, you can choose high beam or low beam by controlling the dimmer switch. When the front light is high beam (☰D), the high beam indicator turns on;

5. Instrument operation buttons

Refer to the instrument description for relevant information;

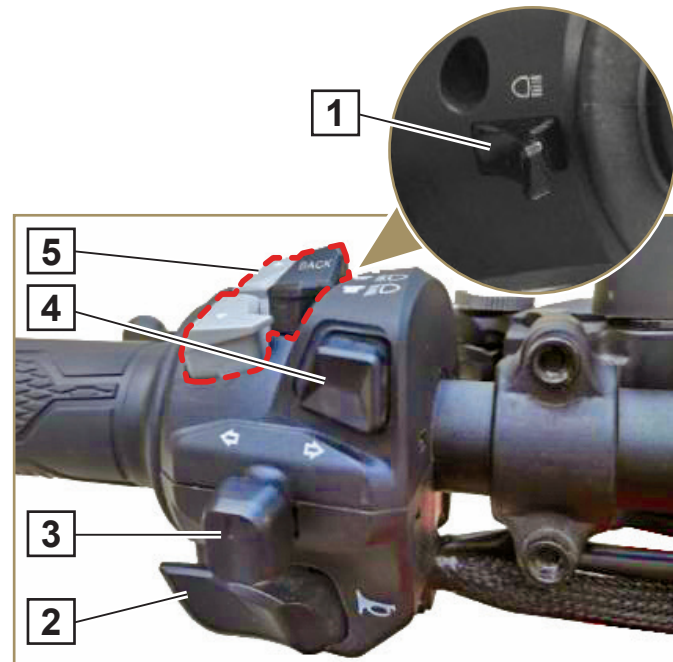

Left handlebar switch

Right hand switch

1. Electric start switch

- (1). When the gear is in neutral position, the ignition button can be used to start the engine;

- (2). In gear engaged position, withdraw the stand, pull the clutch lever and simultaneously press the ignition button to start the engine.

2. Light switch

- (c). The daytime running lights are on;
- (d). Passing beam is ON

3. Flameout switch

When set to "↻", the engine is running; the engine shutdown switch is an emergency switch, if necessary, move this switch to the  position.

4. Emergency warning switch

All turn signal lights and turn signal indicator lights begin to flash continuously;

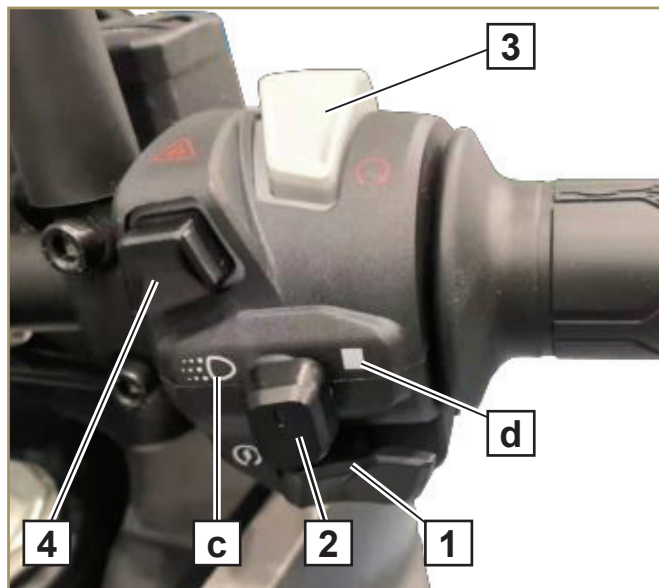

Clutch lever

The clutch lever is a switch that controls the clutch.

- Pull the clutch lever (A) towards the handlebars to interrupt transmission from the engine to the clutch (and to the rear wheels).



IMPORTANT

To avoid premature damage to the clutch components, do not pull the clutch lever when the engine is accelerating.

Distance adjustment

The distance between the clutch lever and the handlebars can be adjusted in function of the size of the driver's hand, the gloves thickness or of other specific needs.

Turn the adjustment screw (B); turn the screw clockwise to distance the clutch lever from the steering wheel or turn it anticlockwise to move it closer.

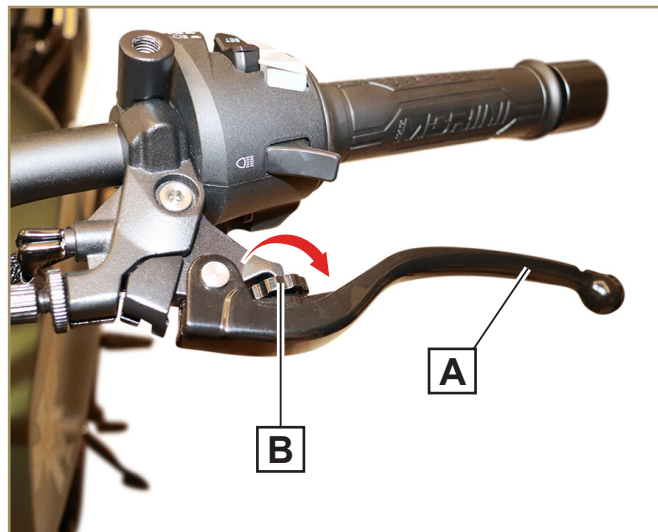

Front Brake lever

- Pull the front brake lever (A) towards the handlebar to activate the two front brake calipers;

Distance adjustment

The distance between the brake lever and the steering handle can be adjusted by rotating the adjusting screw (B) according to the size of the driver's hand, the thickness of the glove or other special needs or riding habits; Turn the screw to the brake pump side, and the lever keep far away from the handlebar, and the opening will increase; on the contrary, the opening will decrease;



Check of the clutch cable

The clutch lever located on the left hand side of the handlebars is equipped with cable adjustment.

Adjustment of the clutch cable

The clutch cable can be adjusted increasing or decreasing its extension.

- Loosen the ring nut (A).
- Adjust the effective useful length of the cable by rotating the regulator (B).
- Tighten the ring nut (A).

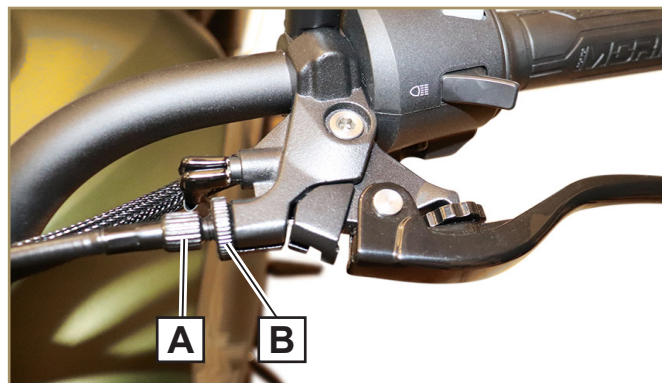

NOTE

Adjust to the best condition of the vehicle according to personal driving habits.

Front fork

NOTE

The front fork is set according to the driver's weight of 75 kg at the factory, and can be adjusted according to actual conditions or special riding requirements during actual use.



INTERVENTIONS

Spring preload

The spring preload (for the two front forks) is set by the adjuster (A).

- Tighten (clockwise) to increase preload.
- Loosen (counterclockwise) to reduce preload.
- The preset value is 4 **EXPOSED NOTCHES (A1)**.

NOTE

The left front fork and the right front fork must be adjusted in the same way.

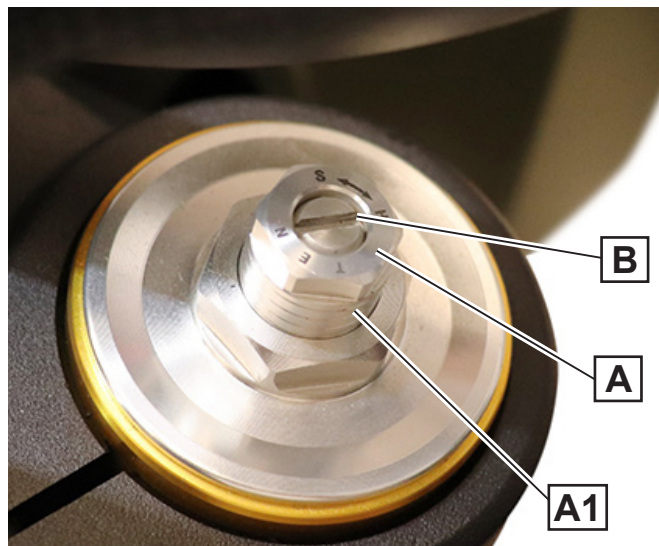

Adjustment of compression (adjustment (B) - left rod)

- Compression can be adjusted through the adjustment screw (B) on the left rod.
- The factory setting is: 11 clicks from all closed.

Adjustment of extension (adjustment (B) - right rod)

- The extension ratio can be change through the adjustment screw (B) on the right rod.
- The factory setting is: 10 clicks from all closed.

NOTE

Turn the *adjustment (B)* screw clockwise to reduce the rebound rate (the suspension becomes stiffer).
The standard position is 3 **TURNS COUNTERCLOCKWISE FROM FULLY CLOSED SETTING.**

Rear shock absorber

• The rear shock absorber is equipped with an external regulator to set the shock absorption parameters according to different load conditions.

NOTE

The factory default setting of the rear shock absorber is calibrated based on a riding weight of 75 kg.



INTERVENTIONS

Spring preload adjustment

• The adjustment ferrules of the spring preload (A and C) are located under the rider's seat, the factory setting is 10 mm.

Use it to adjust the spring preload, as shown below:

- Tighten (clockwise) to increase preload;
- Loosen (counterclockwise) to reduce preload.

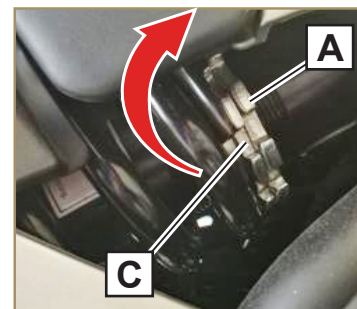
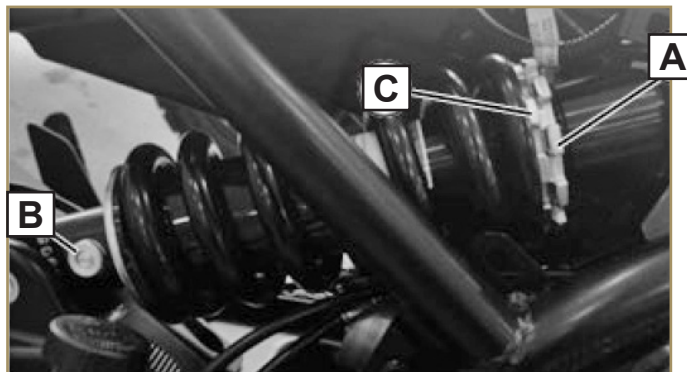

Rebound adjustment

- Use the adjusting screw(B) to adjust the rebound speed of the rear shock absorber.
- Turn the screw clockwise to gradually reduce the rebound speed.
- Turn the screw counterclockwise to gradually increase the rebound speed.
- The standard position is 14 clicks (SCR) - 11 clicks (STR) **COUNTER CLOCK WISE FROM FULLY CLOSED SETTING**; the compression resistance is not adjustable.

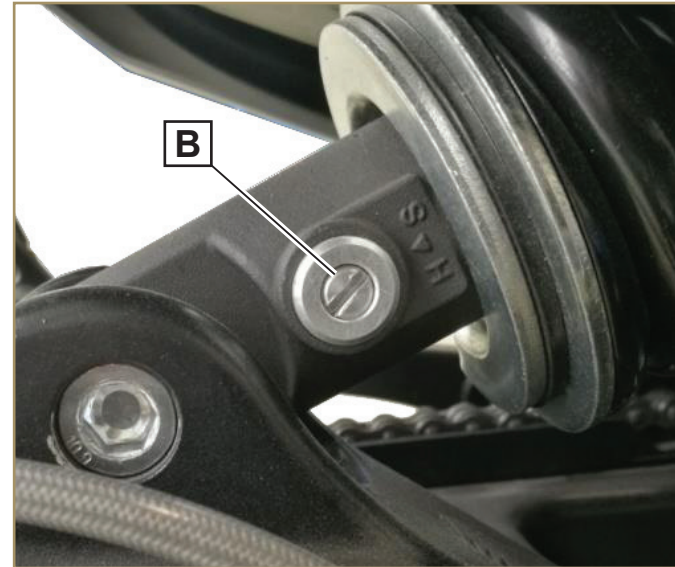

WARNING!

After making any adjustments to the suspension, it is recommended to drive at a low or medium speed first to be familiar with the driving experience of the newly set vehicle.

Gear shifting lever

- Every time the shift lever pedal (A) moves up and down corresponding to engaging different gears (one gear at a time).

Start

- a. Check whether the side stand is in place;
- b. Pull the clutch handle;
- c. Pull the clutch lever;
- d. Press the gear shifting lever (A) to engage the gear 1;
- e. Operate the throttle handgrip, let enough fuel enter the engine in order to avoid its switching off, then gradually loosen the clutch lever.

Gear shift:

- a. Loosen the throttle handgrip and pull the clutch lever.
- b. Raise or press the gear shifting lever to switch to a higher or lower gear.
- c. Turn the throttle knob and simultaneously release the clutch lever.

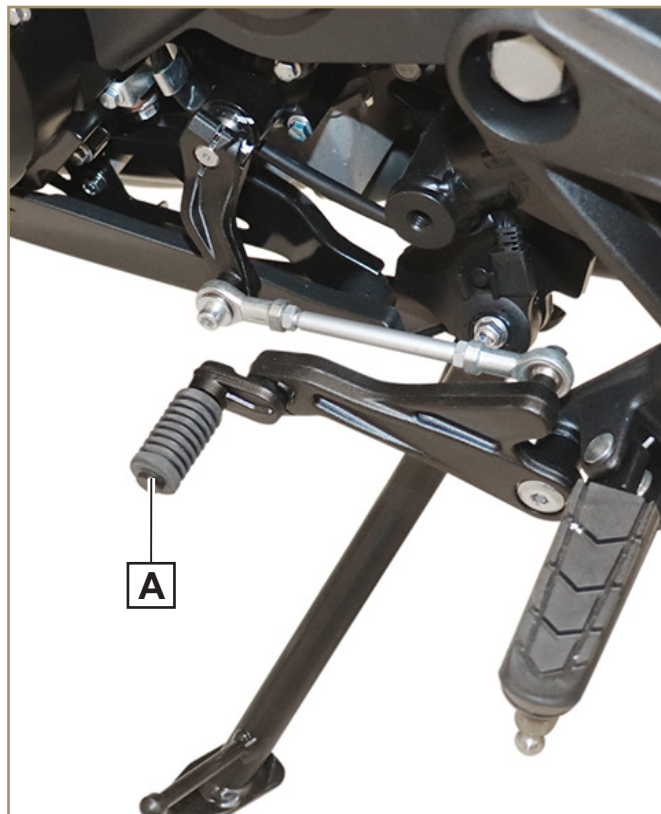

Position adjustment

- The shift pedal can be adjusted according to the requirements of the rider.

The adjustment method is as follows:

- Use a wrench to loosen the nut (c) and nut (d);
- work on the adjustment bar (E) to lower or raise the gear shifting lever position based on the respective needs;
- Sit in the main seat to check if it is in the right place.

Tighten nut (c) and nut (d) completely.

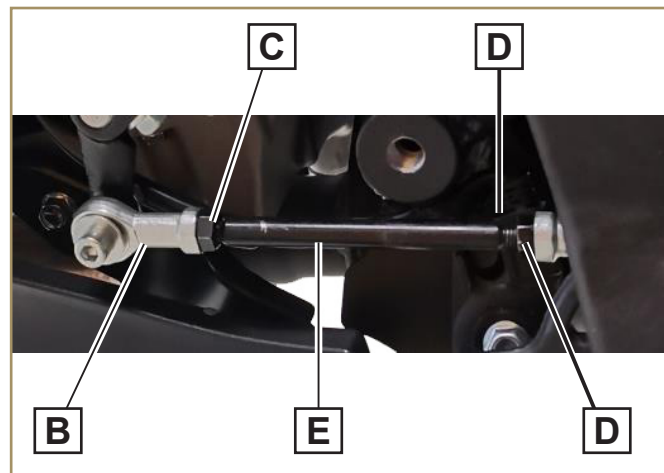

Rear Brake Pedal (1)

The rear brake is activated by hydraulic pressure on the pedal.

Adjust the position of the rear brake pedal

- To adjust the rear brake pedal, loosen the locking nut (A) and turn the regulator (B) until the brake lever reaches the desired position.
- Sit on the seat and check the position.
- Tighten the lock nut (A).
- The rear brake pedal can only lower the height.

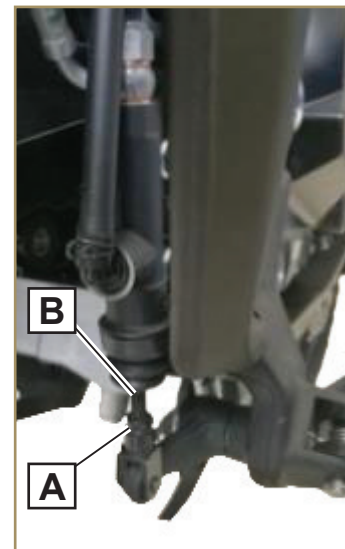

Side Stand



IMPORTANT

Before operating the side stand, check compactness and uniformity of the support surface. Lawn, muddy or rugged terrain, softened asphalt and other ground can cause the motorcycle to tip over and cause serious damage;

If it is a steep slope, park the motorcycle with the front wheel facing up;

When lateral inclination or bumps occur, park the side stand on the most possible flatroad;

Regularly check whether the spring return and the safety sensor (A) are working properly;

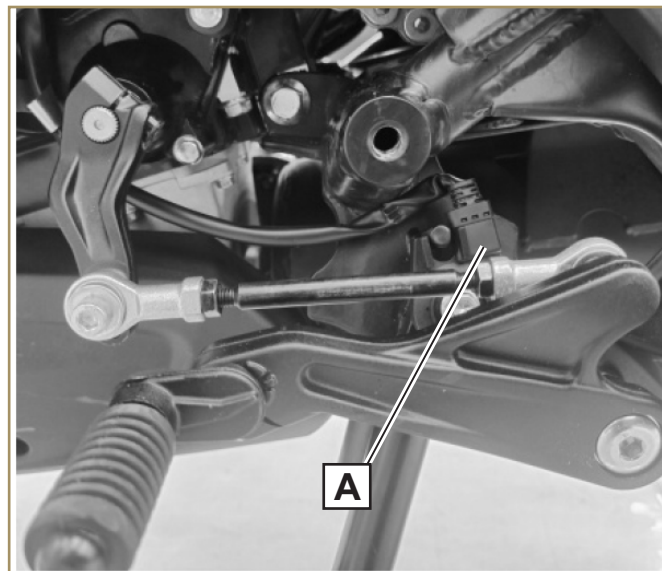

WARNING!

Do not sit on the seat when parking the vehicle with side stand.

Tires

Type: **Tubeless tire**

- Front 120/70 R18;
- Rear 120/60 R17

	Tire pressure(bar)	
	front	rear
Only driver	2.4	2.5
With passenger	2.4	2.9

NOTE

Check and restore tire pressure with cold tires.





IMPORTANT

In terms of load (that is, the total weight of the motorcycle), sufficient tire pressure is an extremely important factor to ensure safe driving.



IMPORTANT

Check the condition of the tires every time you drive. Whenever there are cuts, cracks, bulges, etc., the tires should be replaced immediately. When the tire tread is worn out, the tire becomes easy to puncture and malfunction; tire tread marks are an important reference for tire replacement.



WARNING!

In order to ensure safe and stable driving, please use the recommended standard tires and rims, and inflate the tires to standard pressure.



Fuel Tank

Refueling

- Only after stopping the engine and placing the motorcycle on the side stand can allow to open the fuel tank cap.
- Do not smoke or start the engine when refueling.

Fuel tank	Liters
Total capacity	16
Reserve	4



IMPORTANT

Immediately wipe off the fuel spilled from the fuel tank or other parts of the motorcycle.



Terms of use



WARNING!

- The owner of the motorcycle is personally responsible for maintaining the best condition of the motorcycle.
- Improper maintenance, long-term non usage and exposure to bad weather can cause serious damage and threaten the lifespan and performance of the motorcycle.
- Leaking of fuel tanks or flat tires can cause serious consequences. Therefore, it is very important to thoroughly inspect the motorcycle and its main components before use.
- If the motorcycle is not operating normally, the driver must stop immediately and turn off the engine.
- Contact the affiliated service center and/or road assistance.

Run-in (1000 km)



IMPORTANT

Good running-in is essential to the service life of all moving parts to ensure their long-term normal operation. During the running-in period, it is recommended not to drive with the throttle control lever always in the same position.



WARNING!

Remember to perform the first maintenance after driving 1000 kilometers.

Check items before use

Description	Check
Fuel	Remaining quantity
Engine oil	Optimal liquid level and no leakage
Coolant	Optimal liquid level and no leakage
Tires	Pressure-wear-potential damage
Steering	Free rotation in both directions
Suspension	Adjustment and no leakage
Brake	Operation-wear-no leakage
Chain	Proper tension and lubrication
Throttle control	Please control the throttle gently, without unnecessary operation, lubricate and adjust if necessary.
Lights and indicator lights	Check whether the operation is correct.

Riding skills

- Let the engine idle for a few minutes before riding;
- Do not let the engine idle for a long time;
- Do not start the engine indoors or in a poorly ventilated space. Exhaust gas is extremely toxic;
- Don't accelerate too fast when starting, and don't turn the throttle handle suddenly;
- When turning or changing lanes, always use direction indicators to indicate ,etc.;
- Do not accelerate when the brake is working;
- Under normal road conditions, it is best to use the front brake;
- After travelling a long distance under hot conditions, it is advised to let the engine run at idling speed for a few minutes before switching it off.

Safety precautions for the first use of motorcycles

Until the mileage does not exceed 800 kilometers-in all gears, do not exceed 5500 rpm.



IMPORTANT

It is recommended to change the engine speed frequently without exceeding the specified limit. It is also recommended to check the chain tension and lubrication frequently.



IMPORTANT

To ensure that the friction materials (brake pads and brake discs) run in correctly, excessive and prolonged braking should be avoided. The mileage from 800 kilometers to 1000 kilometers 7500 rpm in all gears should not be exceeded.



IMPORTANT

After reaching the first 1000 kilometers, go to a MOTOMORINI authorized service center for the first inspection.

Info before start



IMPORTANT

Before starting the engine for the first time, be familiar with the control operation, because every action must be smooth and without any interference.



WARNING!

Never start the engine indoors. Exhaust gas is highly toxic and may cause coma and death.

Start the engine

- As long as the engine is in neutral gear and the clutch lever is pulled, the engine can be started with the side stand down;
- To start the engine when it is in gear, you must pull the clutch lever and retract the side stand;
- Do not turn the throttle handle.

NOTE:

The engine start does not require any manual cold start device. The electronic control unit manages the engine start and automatically determines the most suitable idle speed according to the temperature, humidity, atmospheric pressure and the internal temperature of the engine.

Engine Start

- Turn the key to the "on" position (C);
- Turn on the emergency flameout switch to the operating position (A);
- Press the start button (B) to start the engine with- in 5 seconds, if the engine fails to start within 5 seconds, please release the start button, press the start button again after 3 seconds, and repeat the above actions.

NOTE

If the engine fails to start within 3 times, please check the battery level.

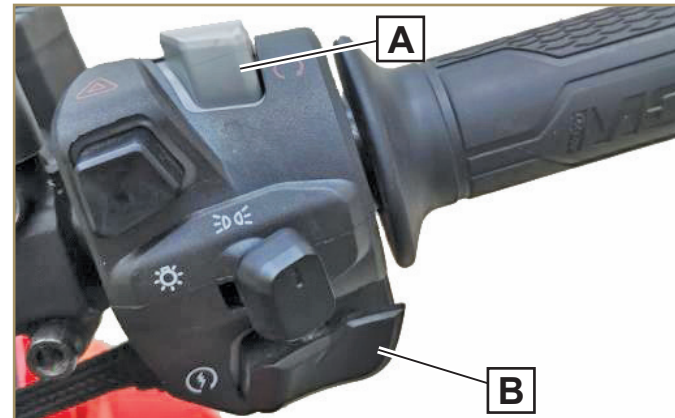
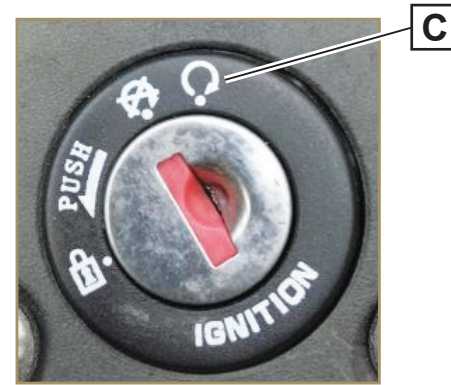

IMPORTANT

A few seconds after the engine is started, the oil pressure warning light will automatically go out. If the indicator light is still on, immediately turn off the engine and check the oil level. If the oil level is correct, please contact MOTO MORINI Service Center



IMPORTANT

Do not run the engine at an excessively high speed. The oil must gradually heat up in order to reach all parts that need to be lubricated.



WARNING!

When the engine is started, the warning light (ABS) is on. If it exceeds 5km/h, the warning light is off.

If the light stays on, stop the engine immediately and restart the motorcycle. If the warning light does not turn off, please contact a Moto Morini Authorized Service Center.

Acceleration

- As already hinted, after starting the engine it is necessary to let it run at idling speed for a few minutes. To start motion, completely pull the clutch lever and firmly push the gear shifting lever to engage the first gear.
- Slowly release the clutch lever, accelerating gradually;
- To switch to the second gear, release the throttle, pull the clutch lever, raise the gear shifting lever with your foot, release the clutch lever and accelerate at the same time. Follow the same process for all the other gears. To shift down the gears, release the throttle command, pull the clutch lever, then engage the lower gear and release the clutch lever.



IMPORTANT

On winding roads, such as mountain roads, when the engine speed decreases, downshifts should be carried out in time according to the vehicle speed.

Deceleration and Braking

- Except for sudden obstacles, the brakes must be used gently to avoid locking the wheels and prevent the motorcycle from losing control.
- Decelerate by shifting gears and using engine brakes, and then adjust the braking force by using two brakes.
- On slippery or bumpy roads, roads with holes, poorly repaired roads, granular debris, etc., it must be adjusted to the corresponding mode. In fact, in this case, the traction will undoubtedly be affected, so the brakes must be used carefully.
- On long and steep slopes, shift gears and rely on the braking ability of the engine. Use the brake briefly; continuous use will inevitably cause the friction material to overheat, which will reduce the braking efficiency.

Stop the vehicle

- Release the throttle command to decelerate gradually. Pull the clutch lever, shift down gears and engage neutral gear (position between the 1st and the 2nd gear), then use the brake to stop the motorcycle.

**IMPORTANT**

When the engine is off, do not leave the key in the vehicle to avoid damage to the electrical components.

Parking the vehicle.

- Put down the side stand of motorcycle;
- Lock the steering lock;
- Do not park the motorcycle near heat sources;
- When parking for a short time in low visibility conditions, please keep the parking light on;
- Do not leave the light on for a long time to avoid draining the battery;
- Do not leave the ignition key in the vehicle, and do not leave the motorcycle unattended, even for a few minutes;
- Do not park the vehicle on dry leaves, plastic materials or wooden surfaces, because the high temperature of the silencer with catalytic may cause fire;
- Do not park your vehicle under a tree. In some seasons, resin residue, fruits or leaves may fall off the tree. These elements may contain chemicals that can damage paint and plastic parts.

General cleaning



IMPORTANT

- Do not wash the motorcycle immediately after use. Water that evaporates in close contact with hot surfaces may cause stains;
- Do not wash the motorcycle under direct sunlight, especially in summer, because the wash liquid may dry out before rinsing, resulting in damage to the paint;
- Avoid high-pressure water or high-pressure air from entering electrical components, vents, edges of exhaust silencers, instrument panels.



IMPORTANT

If the engine parts are very dirty, please use a specific degreasing product. Avoid contact with painted parts, chains, sprockets, brake discs, etc. When cleaning plastic and rubber parts, never use solvents or diluents.

NOTE

In order to maintain the gloss of painted and metal parts, if the motorcycle is used under the following conditions or situations, it should be cleaned regularly: atmospheric pollution, high atmospheric salinity, rain or atmospheric humidity, contact with salt or deicing products used in winter. Pay attention to whether there are industrial powder residues, tar stains, dead insects, etc. on the motorcycle body.

To remove dirt on painted parts, use a low-pressure water jet to moisten thoroughly, and remove dirt with the help of a soft sponge and vehicle wash liquid. Always use high-quality organic products and avoid harsh cleaners and solvents. Rinse with clean warm water and carefully dry all surfaces with a deerskin cloth.



WARNING!

After cleaning, the brake may not work properly. Because there is water on the friction surface of the brake system, it may temporarily affect the braking, and the brake disc must be cleaned with a special cleaning agent for motorcycles.

Long-term parking

Before storing the motorcycle for a long time, such as in winter, do the following:

- General cleaning
- Raise the motorcycle so that the tires can be lifted from the ground and deflate.
- Remove the battery, the battery must be charged periodically (check and recharge every month).

Cover the motorcycle with a suitable cover to protect the vehicle paint and prevent moisture.

Maintenance

In order to keep the motorcycle in good running condition, regular maintenance must be carried out in accordance with the maintenance chart;

1. Periodic inspection

Periodic checks	period every ↓	* Total mileage display Km/miles						
		Whichever comes first →						
		1000 600	6000 3700	12000 7400	18000 11100	24000 14800	30000 18500	36000 22200
Check and cleaning of the air filter				●		●		●
Valve clearance-check	42000 km 25900 mi							
Throttle system (clearance, flexible return)-check	1year	●		●		●		●
Idle speed-check		●		●		●		●
Fuel leak (fuel pipe)-check	1year	●		●		●		●
Fuel pipe damage-check	1year	●		●		●		●
Fuel pipe installation-check	1year	●		●		●		●
Check and/or cleaning of the throttle body			●	●	●	●	●	●
Coolant level check		●		●		●		●
Coolant leak-check.	1year	●		●		●		●

Damage to radiator and pipeline-check.	1year	●		●		●		●
Radiator and pipeline installation-check.	1year	●		●		●		●
Intake system damage-check				●		●		●
Clutch and drive chain								
Clutch operation (clearance, engagement, disengagement)-check		●		●		●		●
Transmission chain lubrication-inspection#	600 km 371 mi							
Transmission chain tightness-check#	1000 km 600 mi							
Wear of transmission chain-inspection#				●		●		●
Wear condition of transmission chain guard-check				●		●		●
Rim and tire, wheels bearings								
Tire pressure-check		●		●		●		●
Rim/tire damage-check				●		●		●
Tire surface wear and abnormal wear-check				●		●		●
Wheel bearing damages check				●		●		●
Brake pedal pin lubrication		●		●		●		●
Braking System								
Brake fluid leakage-check	1year	●	●	●	●	●	●	●

SEIEMMEZZO STR-SCR

Damage to the brake fluid pipe-check	1year	●	●	●	●	●	●	●	●
Brake pad wear-inspection#			●	●	●	●	●	●	●
Brake fluid pipeline installation-check	1year	●	●	●	●	●	●	●	●
Brakes fluid level check	6 months	●	●	●	●	●	●	●	●
Brake control (braking force, clearance, flexible action)-check	1year	●	●	●	●	●	●	●	●
Brake light switch operation-check		●	●	●	●	●	●	●	●
Suspensions									
Front fork/rear shock absorption (smooth cushioning)-check				●		●			●
Front fork/rear shock absorber hydraulic oil leakage-check	1year			●		●			●
Control system									
Steering clearance-check	1year	●		●		●			●
Steering Bearing-Lubrication	2 years					●			
Electrical system									
Light and switch operation-check	1year			●		●			●
Headlight-check	1year			●		●			●

Engine start-up switch check	1year			●		●		●
Engine switch-off switch operation check	1year			●		●		●
Chassis								
Chassis Parts-Lubrication				●		●		●
Check for tightening of studs and nuts and torque values		●		●		●		●

2. Regular replacement

Regular replacement items	period ↓ every	* Total mileage display Km/miles				
		Whichever comes first →				
		1000 600	12000 7400	24000 14800	36000 22200	48000 29600
Air filter element#	2 years		●	●	●	●
Engine oil#	Every 6000 km / First 1000 km					
Oil filter	Every 6000 km					
Fuel pipe	4 years					●
Coolant	2 years				●	
Radiator, pipeline	2 years				●	
Brake fluid line	4 years					●
Brake fluid (front/rear)	2 years			●		●
Brake pump rubber seal	4 years					●
Spark plug			●	●	●	●
Transmission flexible coupling			●	●	●	●

Daily maintenance

These maintenance tasks must be considered and must be strictly performed by the owner; the long life and performance of the motorcycle depend to a large extent on these operations.

NOTE

Routine maintenance operations are usually carried out by the owner, but often require sufficient technical training and specific tools; if in doubt, it is recommended to contact the MOTOMORINI authorized service center, which will provide safe and competent services.

Before starting any maintenance work or inspection, place the motorcycle on a flat, solid ground in a well-ventilated protective space, and check whether the engine and exhaust system are sufficiently cooled to avoid spontaneous combustion.



INTERVENTIONS

The maintenance operations marked with this symbol are the exclusive rights of authorized personnel and must be done in the MOTOMORINI authorized service center;

If these rules are not followed, the manufacturer will waive all responsibilities and claims and will invalidate the warranty (if it has not expired), as this is considered a "vehicle modification". MOTOMORINI also does not encourage you to perform these operations yourself, because they may cause serious damage or death.

Engine oil

Check liquid level per km: 1,000

- The oil level must be checked for cold or warm engines; if the engine is overheated, wait a few minutes for the oil to stabilize in the oil sump.

Keep the motorcycle perpendicular to the ground.

- The liquid level can be checked from the view glass and is correct when it is in the middle of the window.
- If the level of oil is lower than the central line of the indicator, top it up from the top filling cap (T).
- Oil: 10W40-SN grade fully synthetic motor oil 



NOTE

Check the oil level before a long trip.

NOTE

If you use a funnel or similar tool when filling engine oil, please check whether it is clean; foreign matter or water entering the engine may cause serious damage.

- After topping up, remount the filling cap, start the engine and let it run at idling speed for a few minutes, then check that there is no oil leakage and that the indicator on the dashboard switches off after a few seconds. If that does not happen, stop the engine and perform the necessary checks.
- About three minutes after turning off the engine, check the oil level again.



WARNING!

Do not mix different incompatible oils to avoid damage to the engine. If there is no recommended engine oil, please use a compatible engine oil. The oil compatibility can usually be checked on a specific chart at a gas station or specialty store.

MOTOMORINI is not responsible for any damage caused by the use of oil with different characteristics from the recommended oil.

Brake fluid

Brake fluid DOT4.0 



IMPORTANT

Under normal braking conditions, check every 10,000km

Brakes are the most important component to ensure driving safety, and they must always be in perfect condition. Both wheels of the motorcycle are equipped with hydraulic disc brakes.



WARNING!

Brake fluid and clutch fluid are extremely corrosive and may cause serious injury to the owner and damage the motorcycle. The liquid level must always be higher than the "min" indicator displayed on the two liquid storage tanks. Too low brake fluid level may result in low efficiency of the braking system.



IMPORTANT

Be sure to use the recommended liquid taken from an unopened container. Be careful not to let foreign objects, water, etc. enter together with the liquid. If the oil brand needs or must be changed, the entire system must be drained. This operation can only be performed by authorized personnel.

Never mix different and possibly incompatible liquids.

Liquid level check

(Brake fluid)

- Lean the motorcycle to let the liquid be placed horizontally.

Liquid level indicator:

- **Front brake:** Check the fluid level inside the oil tank of the front brake through the inspection glass (A). Check that the level of brake fluid inside the oil tank is at the bottom level (B).
- **Rear brake:** Check that the brake fluid level inside the oil tank (C) of the rear brake is between the "MAX" and "MIN" levels (D).

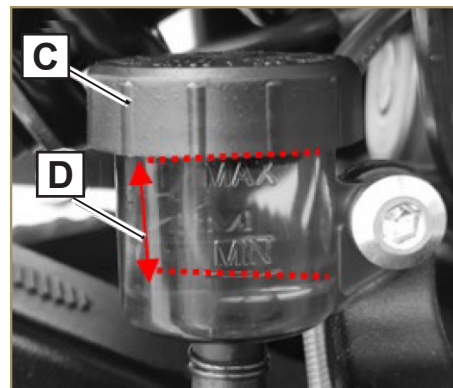
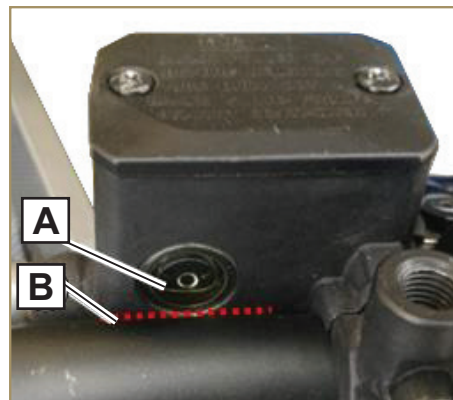

WARNING!

If the brake fluid decreases, do not use the motorcycle, do not fill up the brake fluid, and immediately contact the Moto Morini Authorized Service Center.

Coolant

- The expansion tank (A) of the coolant is located on the left hand side of the motorcycle.

Liquid level check:

- Check the level of coolant inside the expansion tank with the engine and the motorcycle perpendicular to the ground.

NOTE

Engine must be cold.

- The correct level of fluid is between the indicators "F" and "L", visible on the external surface of the tank on the left hand side of the motorcycle.
- The cover (B) must be removed for any liquid filling.

Coolant type: **GLYSANT G40** 

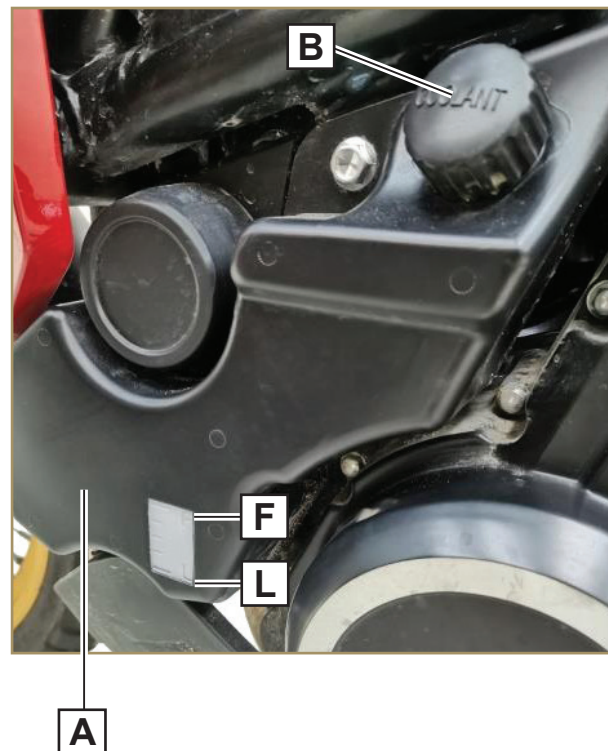



WARNING!

Except in the case of clear emergency, do not add fluid.

NOTE

If the coolant temperature is too high, the fan is automatically operated and it's protected by a fuse.



WARNING!

If the coolant consumption is irregular or the cooling system leaks, please do not use the motorcycle and contact a MOTOMORINI authorized service center.



Brake pads

Wear check

Inspection: every 6000km



IMPORTANT

Used on dusty roads, wet roads, winding roads or mountain roads, the brake pads of motorcycles need more frequent wear inspections.

- It is not necessary to remove the brake pads when performing the inspection.
- There are indicating grooves on the friction material of the front brake pads to determine whether to replace the brake pads;
- When the brake pads are still in good condition, the grooves can be seen.

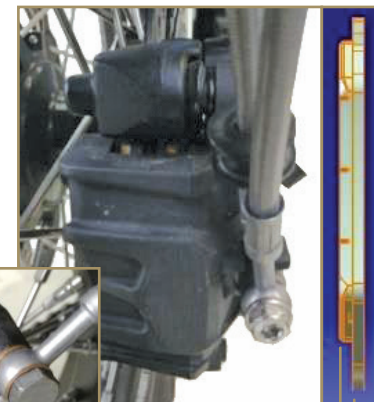

min 4,5mm



INTERVENTIONS

The minimum thickness of the brake pad friction material is 4.5 mm. If one brake pad is excessively worn, both brake pads must be replaced at the same time, and the original brake pads must be used.

Transmission Chain

NOTE

Users need to check the tension and lubrication of the transmission chain frequently.

- Park the motorcycle on level ground:
- Press the chain upward at the middle part of the lower chain:
- Observe the displacement of the chain to judge the tightness; usually the displacement is 25-30mm. If there is a high degree of slack, please adjust the chain tension at the MOTOMORINI authorized service center.

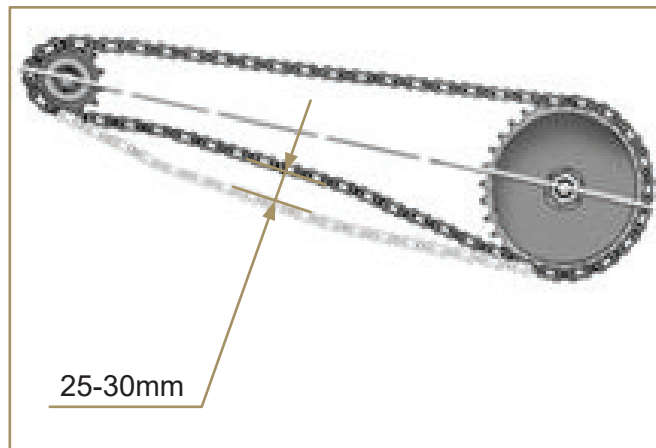

WARNING!

The inappropriate tension of the chain may cause the premature wear of the pinion, crown and of the chain itself.

Check lubrication every 500 kilometers (or more frequently when driving long distances on dusty or wet roads). Use special products for lubrication, and carefully follow the terms of use on the product packaging.

Use the special lubricants for motorcycle chains to lubricate.

Electrical components

Fuses

- Remove the saddle;
- Open the fuse box cover;
- Before replacing the fuse, try to solve the problem that caused the fuse to "burn out";
- Find and remove the blown fuse, and then replace it with a fuse of the same rating.

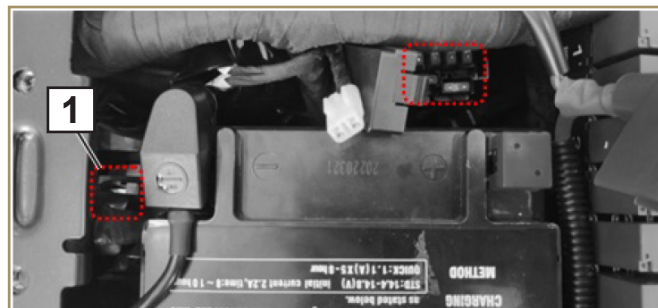

WARNING!

When replacing the fuse, be sure to use a fuse of the same rating, because it may seriously damage the electrical system and cause a fire due to a short circuit.

No.	Ah	Functions
1	30	Engine fuse and spare fuse

No.	Ah	Functions
2	15	Headlamp and signal system
3	5	ABS system
4	10	Lambda sensor heating
5	15	Fuel pump relay, main relay
6	15	Fan relay/start auxiliary relay
7	7.5	ECU
8	15	Spare fuse
9	10	Spare fuse
10	5	Spare fuse
11	25	Spare fuse
12	10	ABS system
13	25	ABS system

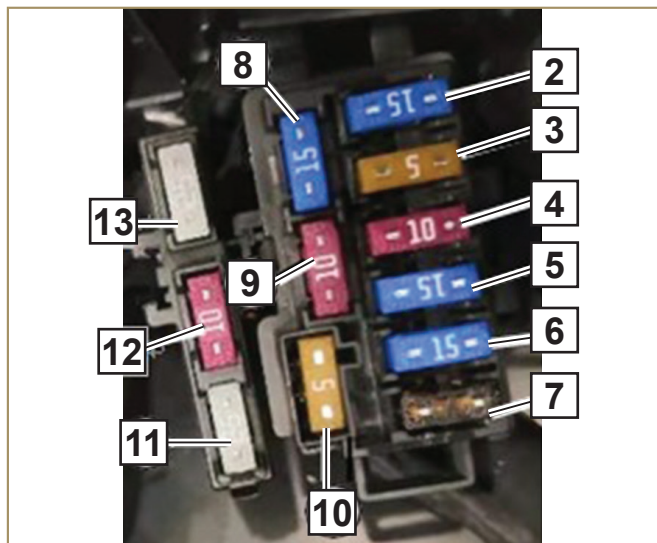

Ignition coils diagnostics sockets

The diagnostics sockets (A) and (B) of the coils are located under the saddle next to the battery and can only be used by MOTO MORINI's technicians.



IMPORTANT

The caps (C) that contain the resistor must be removed by the user to avoid compromising normal use of the vehicle.

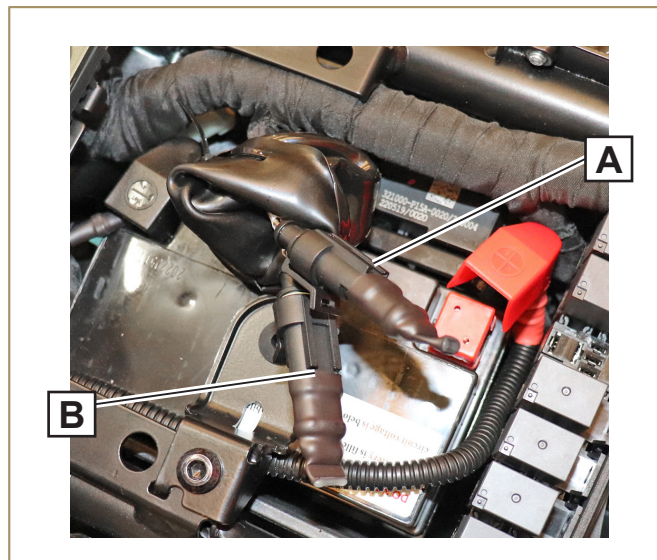

Battery

The battery installed on the motorcycle is a wet maintenance-free type, so there is no need to check the battery electrolyte level or add distilled water.

NOTE

Do not remove the sealing strip, otherwise the battery will be damaged. Do not install traditional batteries on the motorcycle, otherwise the electrical system will not work properly.

Battery Maintenance

It is the owner's responsibility to maintain sufficient power in the motorcycle battery.

Otherwise, it may cause the battery to lose power and cause the motorcycle to break down.

If your motorcycle is not used for a long time, you should use an appropriate charger to charge the battery or remove the vehicle battery.



WARNING!

Do not charge or place the battery near a heat source or open flame; keep out of the reach of children. The battery can only be charged with a dedicated charger, which can be charged in your motorcycle dealership store.

Remove the battery

- Make sure the ignition switch is turned off
- For information on how to remove the driving saddle, consult the section "Driving saddle removal".
- Disconnect the battery cable, first disconnect the negative (-) terminal, then the positive (+) terminal
- Loosen the screws that secure the cables to the battery terminals.
- Remove the battery.



WARNING!

Do not open the battery, do not add distilled water or electrolyte.

Re-Install the battery

- Position the battery in its respective seat.
- Connect the positive (+) cable to the positive (+) terminal, and then connect the negative (-) cable to the negative (-) terminal.
- Tighten the screws that fix the cable to the battery terminals.
- Cover the positive (+) terminal with red insulation.



WARNING!

Connecting the negative wire to the positive terminal of the battery or connecting the positive wire to the negative terminal of the battery will cause serious damage to the electrical system.



IMPORTANT

Pay attention to the location of the terminals and the polarity of the cable.

Red = positive (+)

Black = negative (-)

Headlamp



INTERVENTIONS

Regularly check the beam pattern of the headlights at MOTO MORINI authorized service centers or trusted service centers.

- Adjusting the lights up and down by directly rotating the inner screw under (A) the headlight.
- Adjust the light beam as indicated in the figure.
- Daytime light/front parking light: 3,8/0,3 W.
- Low beam/high beam: LED-14/30W.

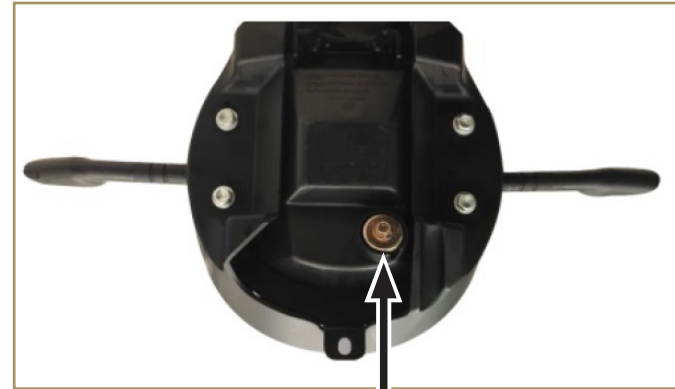

Adjustment device

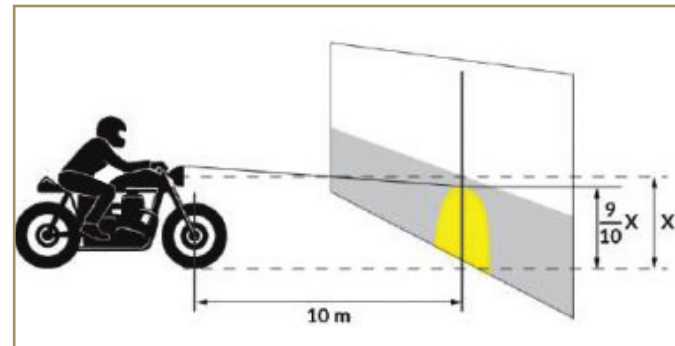

Indicator lights

The direction indicator uses a set of non-replaceable LEDs. If the indicator does not work, the entire indicator must be replaced at a MOTOMORINI authorized service center.

License plate light

The license plate light uses a set of non-replaceable LEDs. If the light does not work, the whole lamp body must be replaced at a MOTO MORINI's authorized assistance centre.

Tail light

The tail light uses a series of LEDs that cannot be replaced. If the light does not work, it must be replaced at a MOTO MORINI's authorized assistance centre.

MOTOMORINI®



ITALIA DAL 1937